

KX15DTAM

15m Dual Technology and Anti-Mask Detector



EN50131-2-4:2008
EN50131-1:2006+A1:2009
PD6662:2010
Security Grade 3
Environmental Class II



ENGLISH

References

A Anti-Masking: The KX15DTAM uses the patented Anti-Masking technology to detect when both PIR and Microwave technologies are Masked. The detector is able to detect aluminium foil, spray and any object position on or in front of the detector with the purpose of obstructing the field of view of the PIR or MW sensors.

A1 The Mask is adjustable between 0 to 1M.

A2 If the Masking area is entered the Blue LED starts flashing to show that the area has been compromised. If the obstacle is removed after 30 seconds the detector will reset to normal. If the obstacle still remains after 1 minute, the MASK and ALARM relay will open and the Green and Orange LEDs will be permanently activated. To reset the detector, the obstacle must be removed and a walk test must be done.

B Blocking: This feature is to detect a partial obstruction of the PIR up to 15m when the panel is disarmed. When blocking is detected the alarm relay will open and the GREEN and ORANGE LEDs will be activated. To reset the blocking, the KX15DTAM must be walk tested so that the PIR and MW sensors are activated.

B1 Blocking Enabled/Disabled: To enable the feature, switch 6 must be OFF and the RI input should be connected to an output on the control panel which gives 0V when DISARMED and removes 0V when ARMED.

C KX15DTAM is supplied with the following:

KXBRACKETW (Wall Bracket), KXBRACKETC (Ceiling Bracket) and K-TAMPER (Back tamper)

D Other Wiring Diagrams

E NOTE: When the 2 optional lenses are used the Microwave range remains at 15m.

Technical Specification

Casing: White, 3mm polycarbonate, 0.4mm HDPE in Lens Area

Lenses: 15m Volumetric fitted. 18m Curtain and 30m Long Range lens supplied.

LED Colours: Orange (Microwave), Blue (Alarm, Mask), Green (PIR).

Sensitivity Selectable: AUTO or Pulse Count 1

Temperature Compensation: Digital

Detection Speed: 0.25 - 2.5m/s

Detection Range: 15m (13m according to EN50131-2-4).

Operating Voltage: 9-16VDC, 13.8VDC typically

Relay Output: 50mA 60VDC, 42 VAC (RMS)

Current Consumption: 50mA 60 VDC, 42 VAC (RMS)

Contact Resistance: <10 ohms

Mounting Height & Range: 1.8M - 2.4M

Tamper Switch: 12VDC 50mA both front and rear

Storage Temperature: -40°C to +80°C

Certified Temperature: -10°C to +40°C

Operating Temperature: -30°C to +70°C

Dimensions & Weight: 117 x 69 x 50mm, 125g without bracket

Emissions EN55022 Class 2. Immunity EN50130-4

NOTE 1: The mask adjustment needs to be set to half way to comply with EN50131-2-4.

NOTE 2: Do not partially or completely obscure the detector's field of view with large objects such as furniture.

Warranty

This product is sold subject to our standard warranty conditions and is warranted against defects in workmanship for a period of five years.

In the interest of continuing improvement of quality, customer care and design, Pyronix Ltd reserves the right to amend specifications, without prior notice.

Product Warning Information

For electrical products sold within the European Community. At the end of the electrical products life, it should not be disposed of with household waste. Please recycle where facilities exist. Check with your Local Authority or retailer for recycling advice in your country.

This product operates in a European non-harmonised frequency band.

Hereby Pyronix declares that this detector is in compliance with the essential requirements and other relevant provisions of Directive 1999/5/EC. The declaration of conformity may be consulted at www.pyronix.com/product-compliance.php

This product is approved for use in the Residential, Commercial and Light Industrial Environment.



START

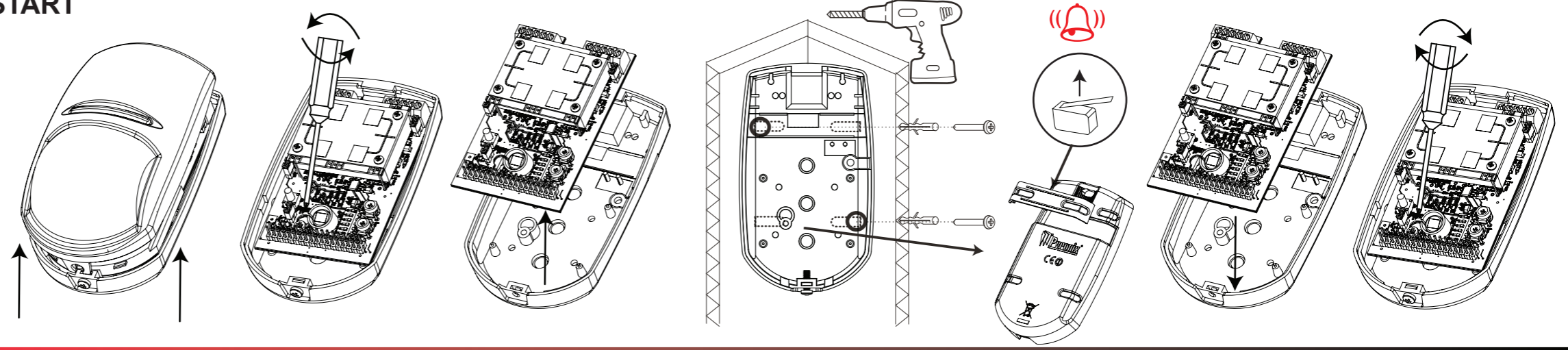

A

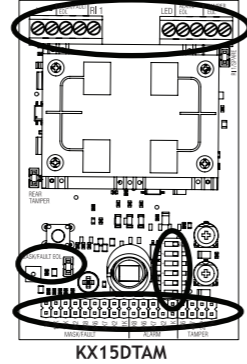

KX15DTAM

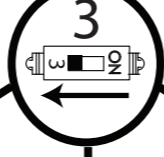

3

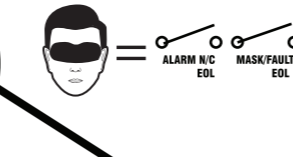

3EOL



2DEOL



N/C

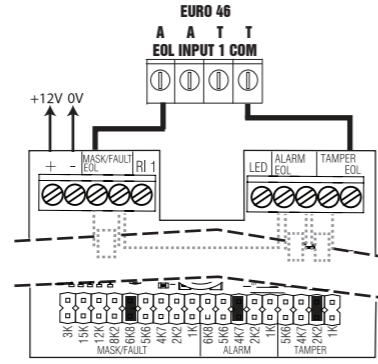

KX15DTAM

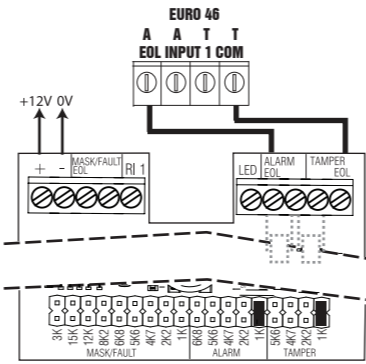

KX15DTAM

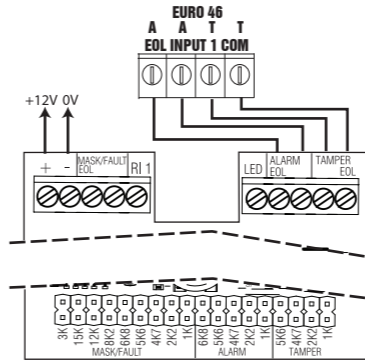

KX15DTAM

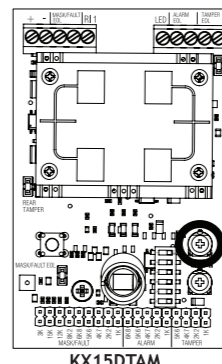

KX15DTAM



AM ADJUST OFF



2DEOL



N/C

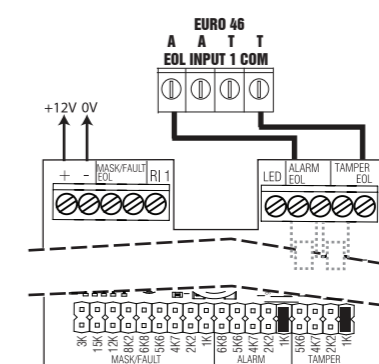

KX15DTAM

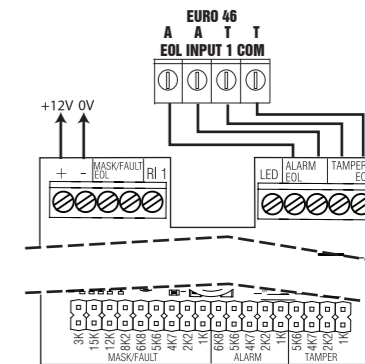

KX15DTAM

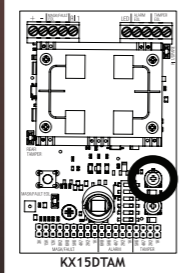

KX15DTAM

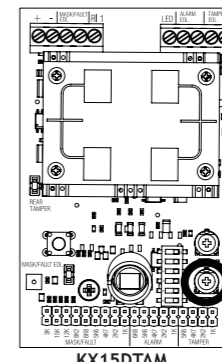
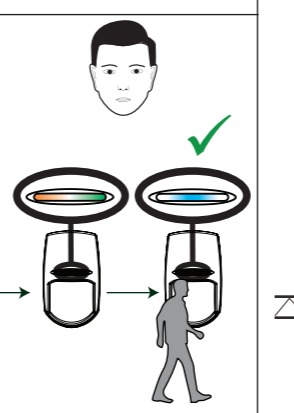
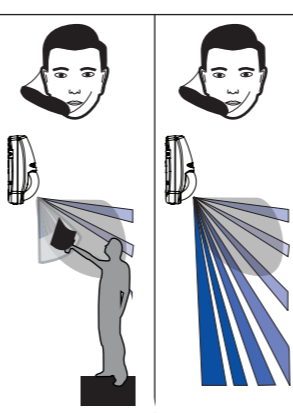
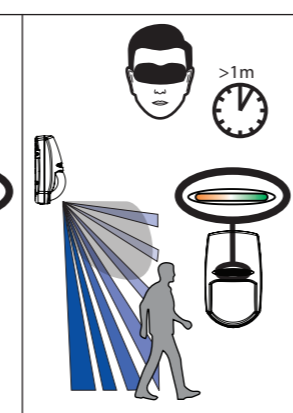
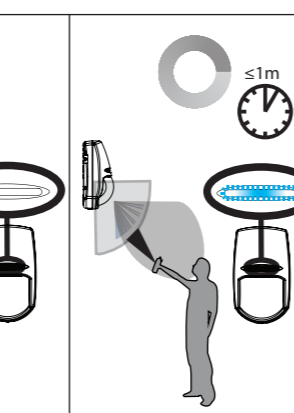
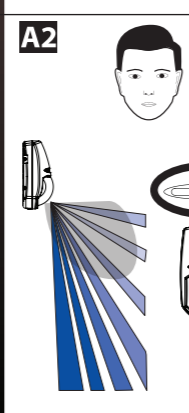
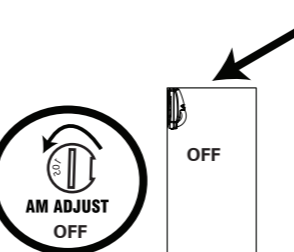
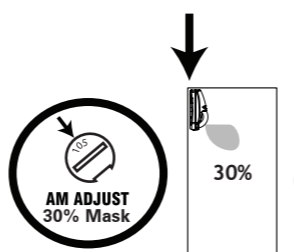
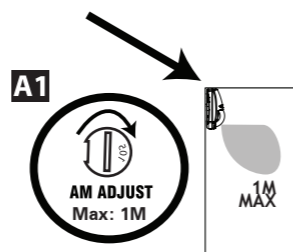

KX15DTAM

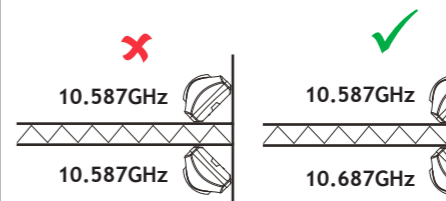
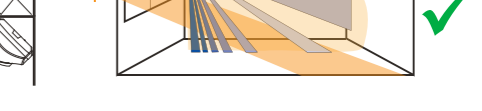
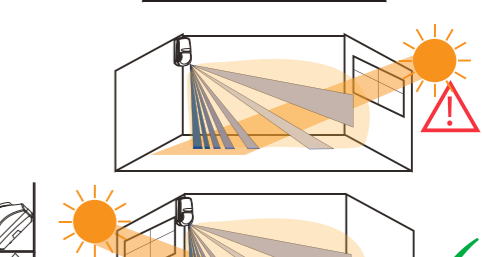
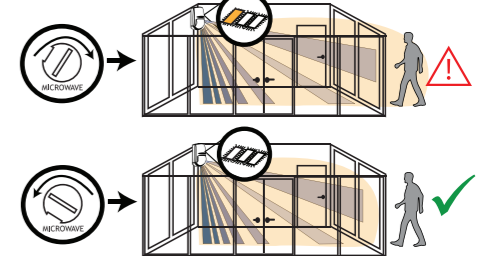



B

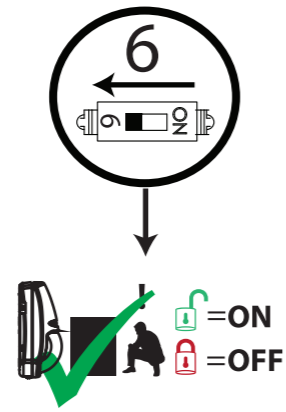
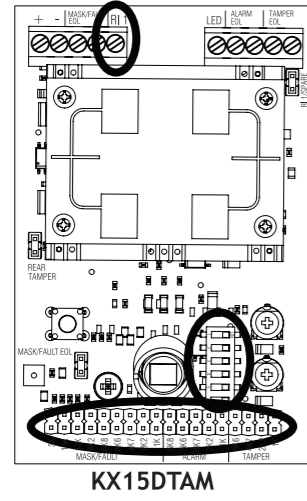

B1

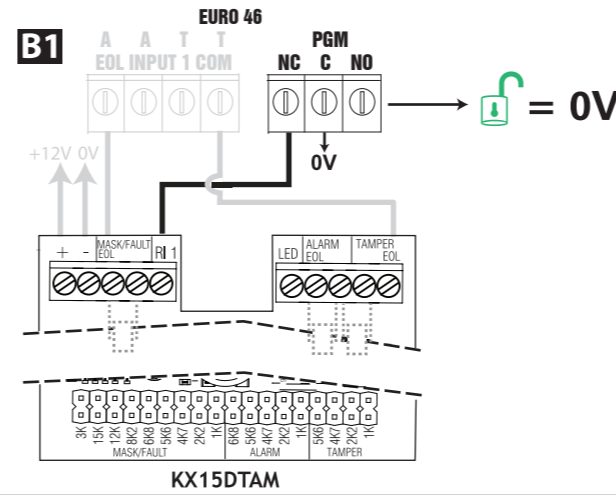

PROGRAM OUTPUTS?
Endstation PGMs?
PGM [0000] Not Used
PGM [0022] Final Arm Any

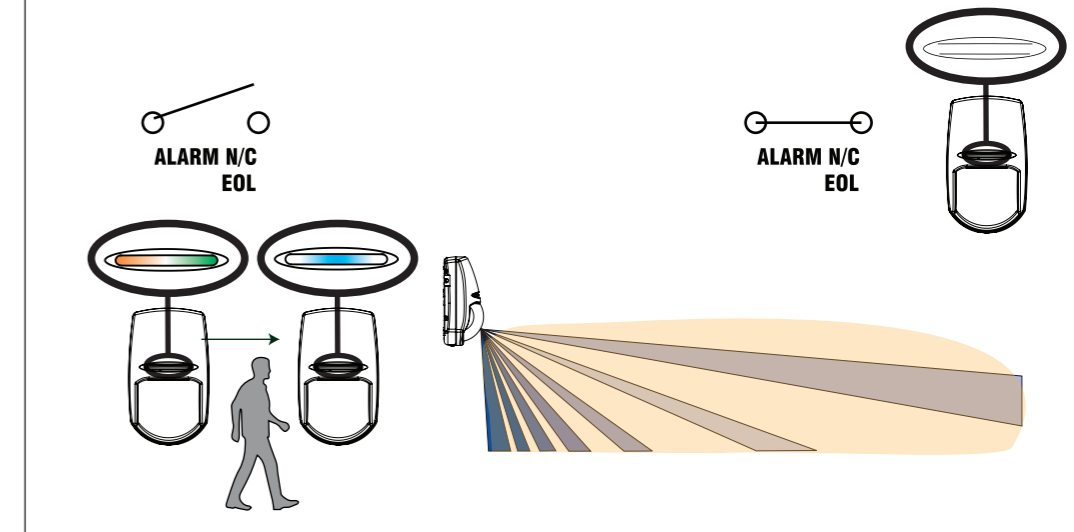
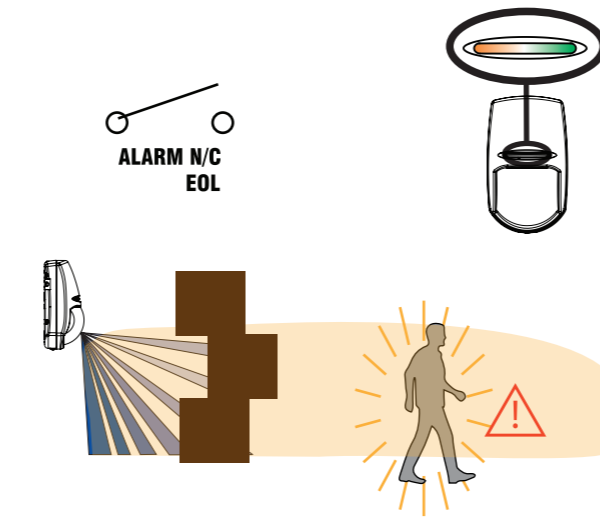
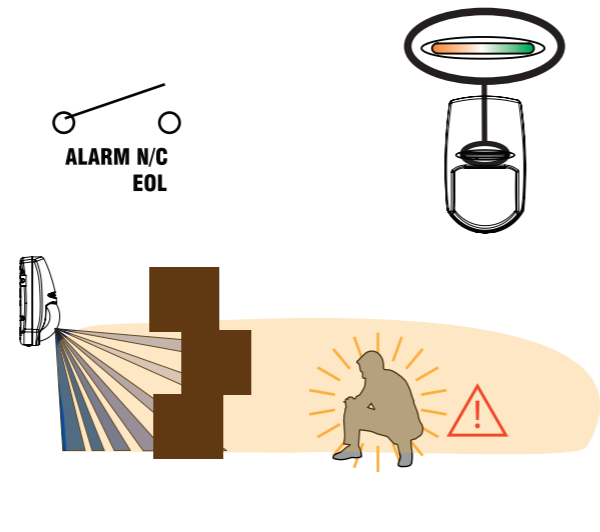
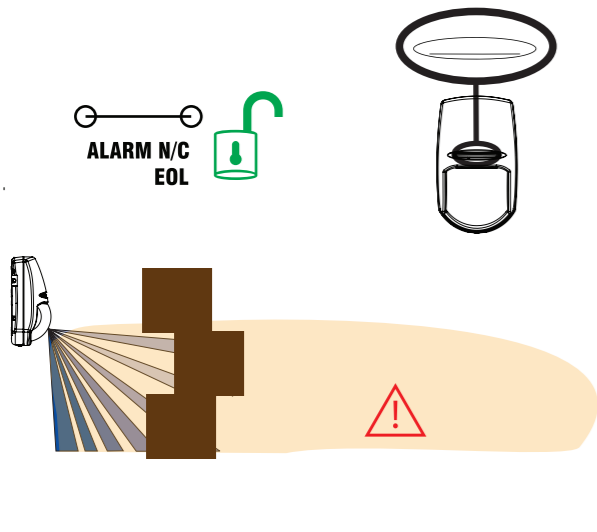
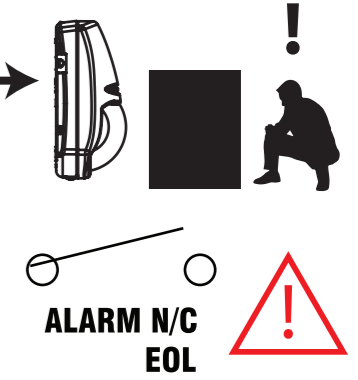

E

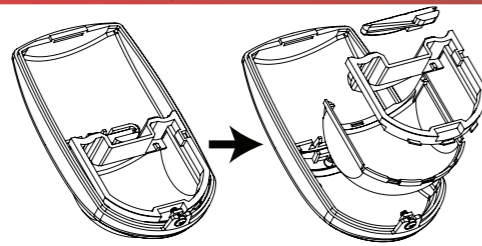

KX15-VL: 15m Volumetric Lens

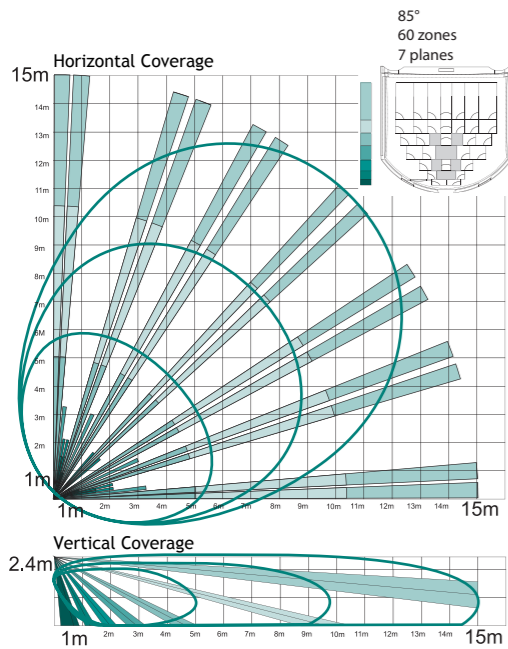

KX18-LC: 18m Curtain Lens

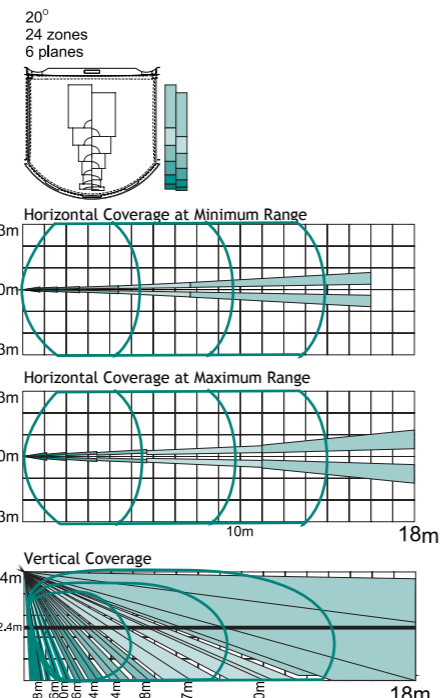

KX30-LR: 30m Long Range Lens

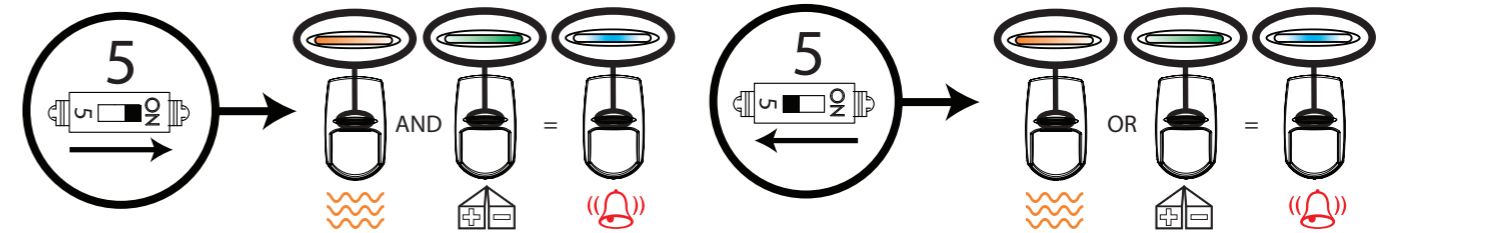
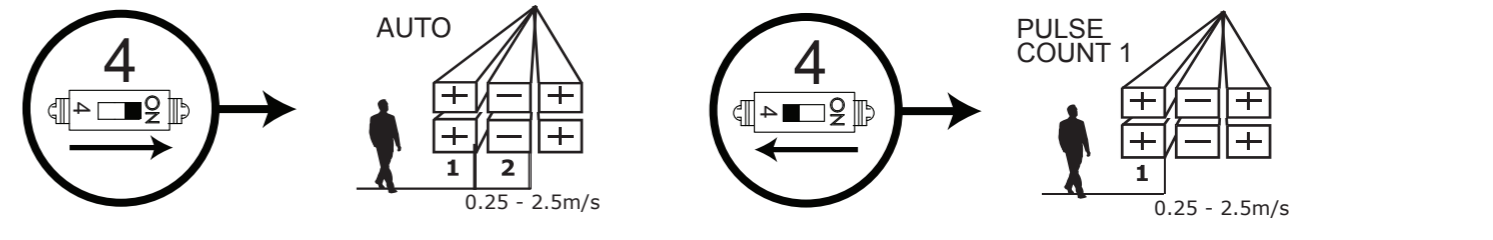
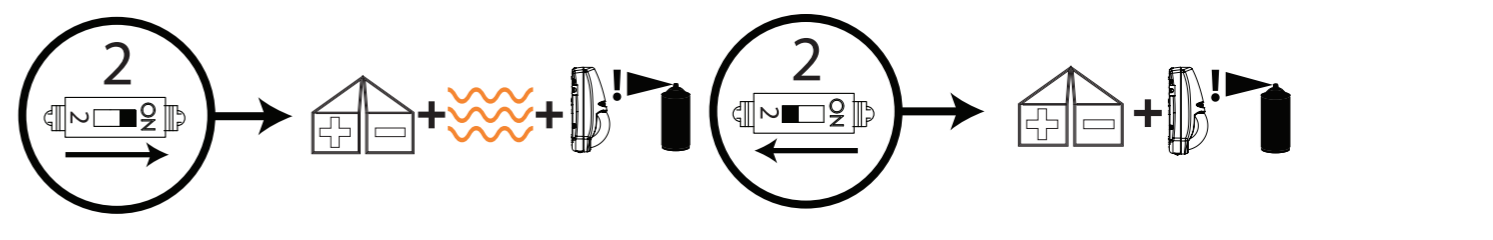
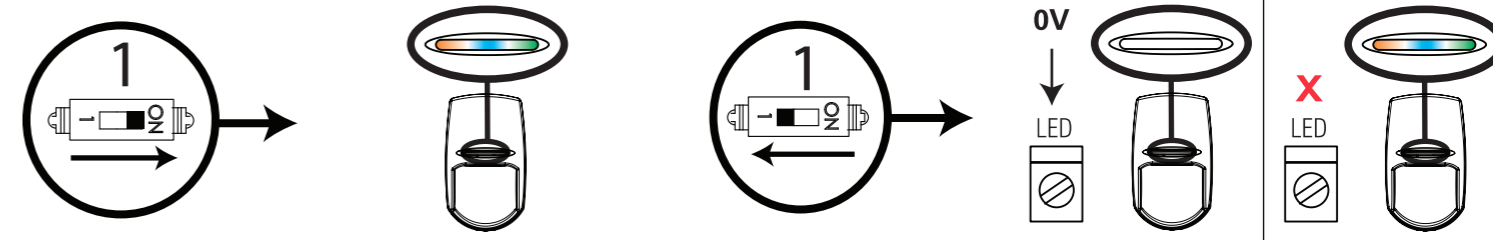
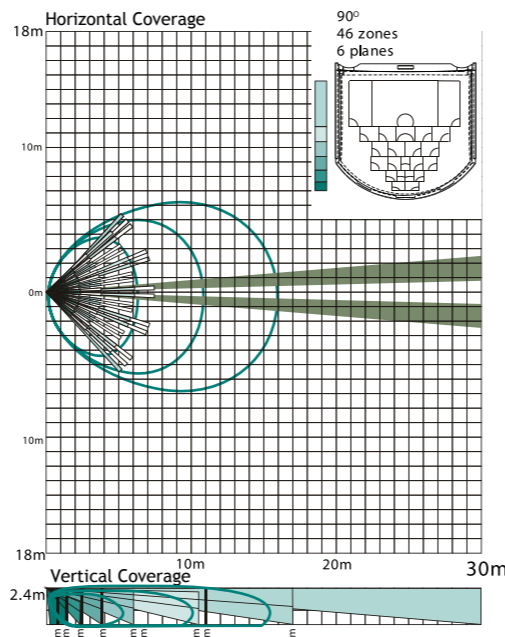

C

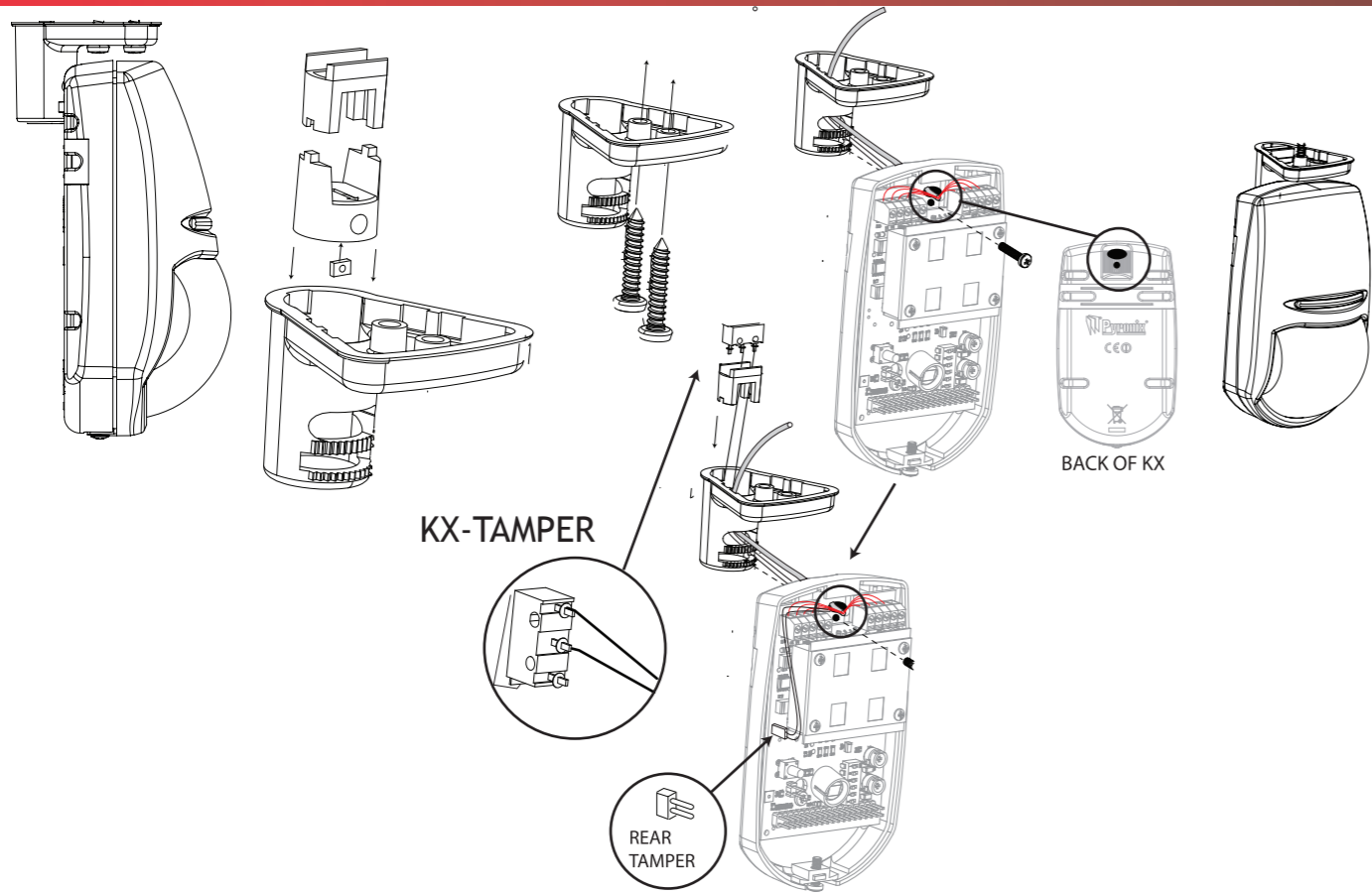

C

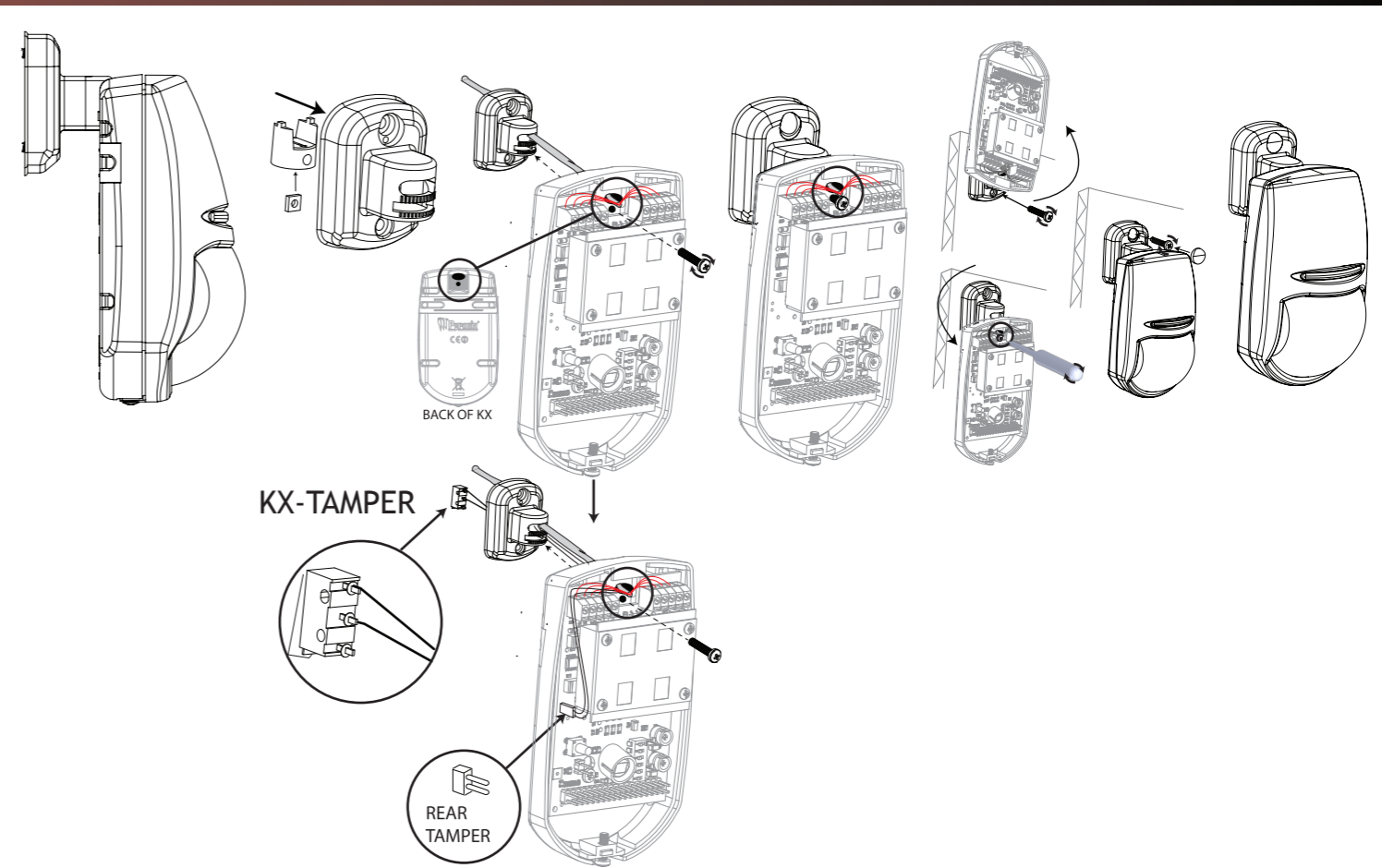

D

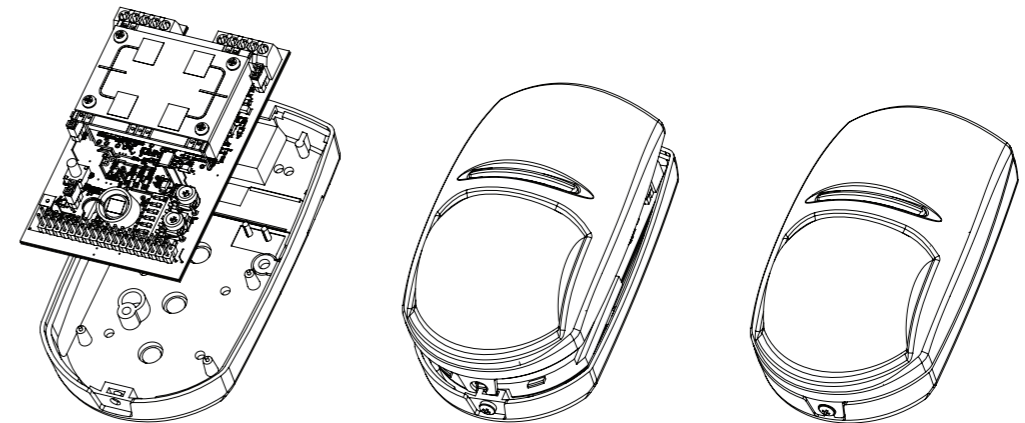
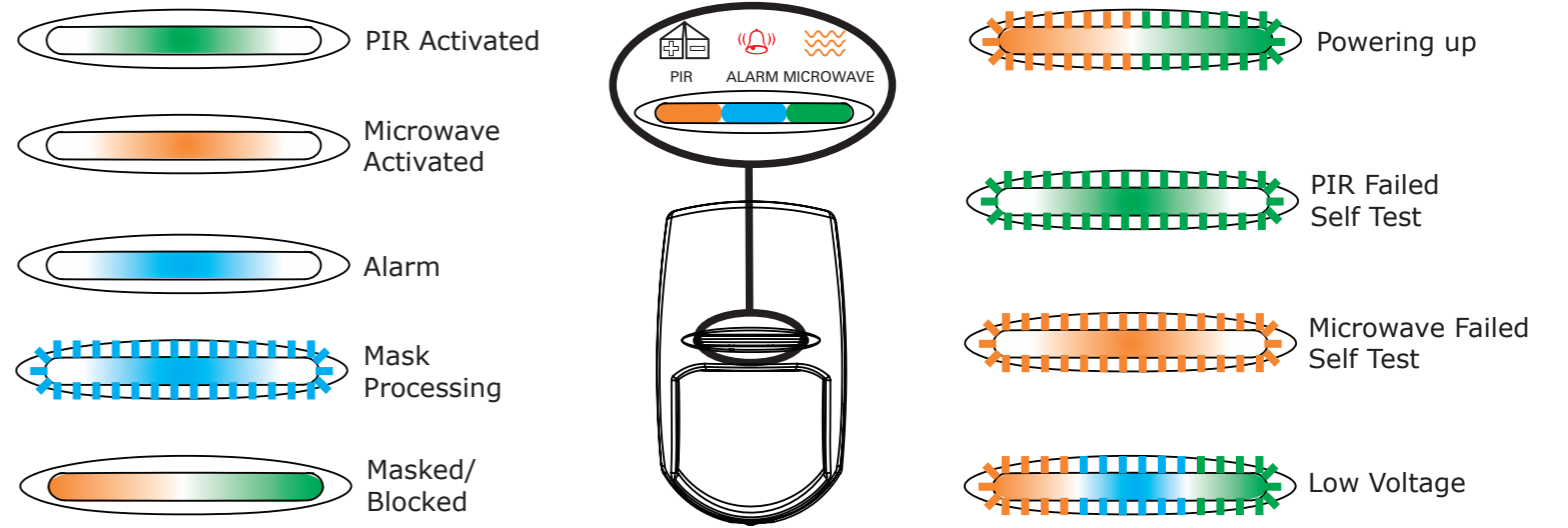
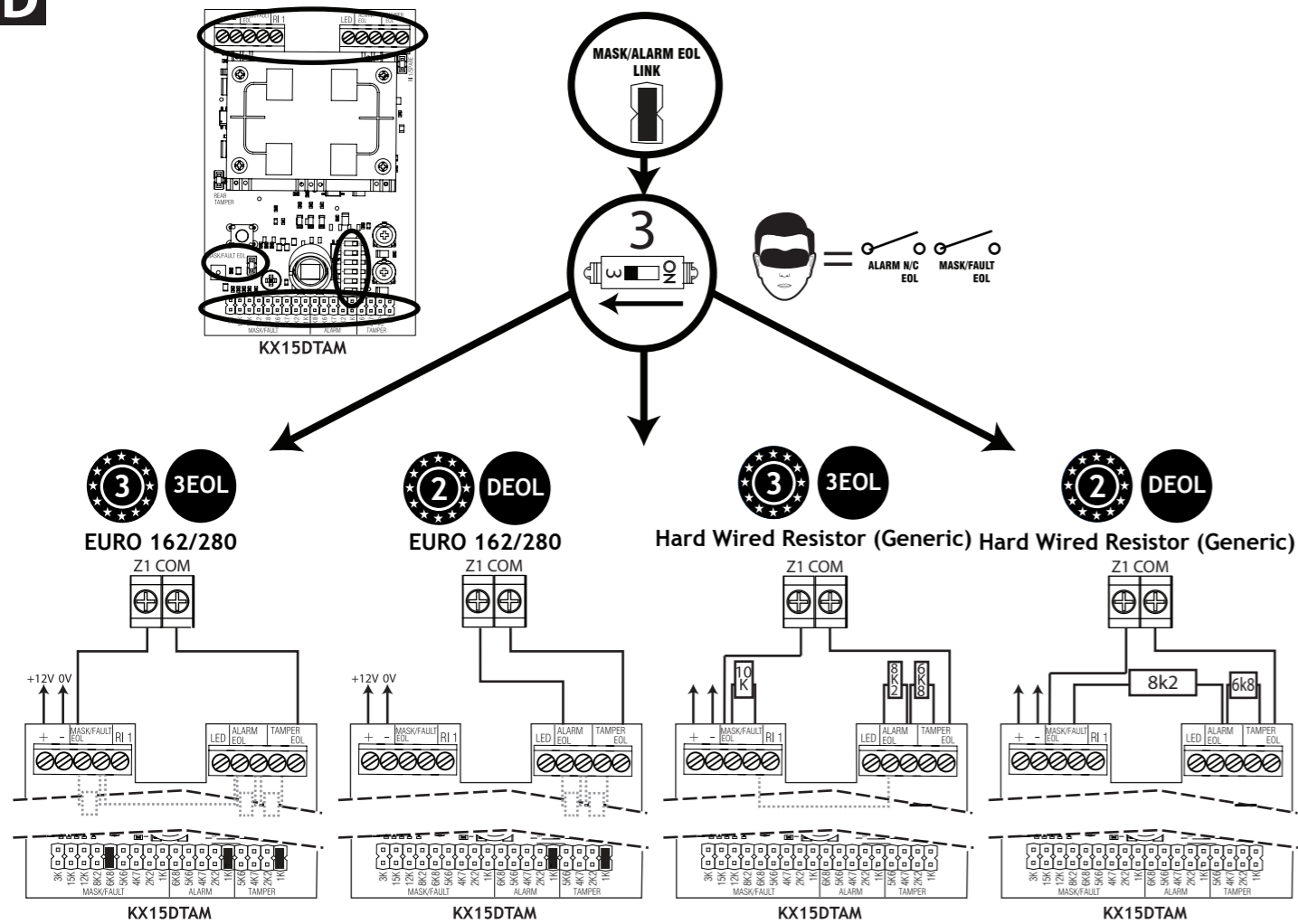

Grade 3 DEOL Connections: Connecting all three technologies to one input

Pyronix Ltd

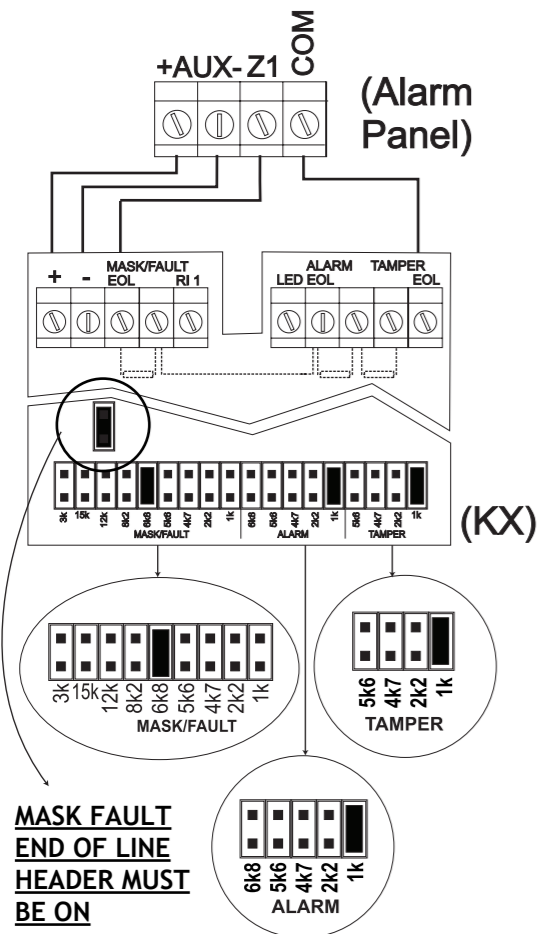

Castle

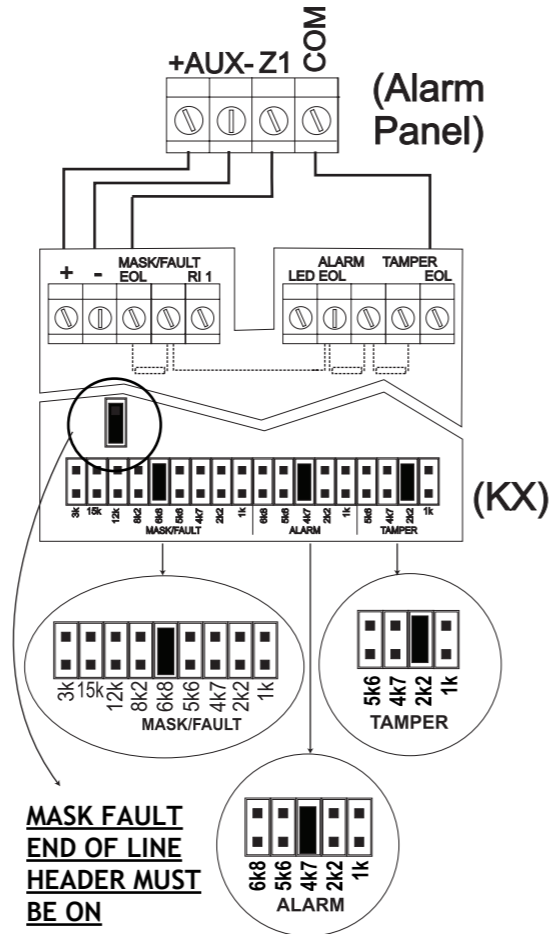

Honeywell

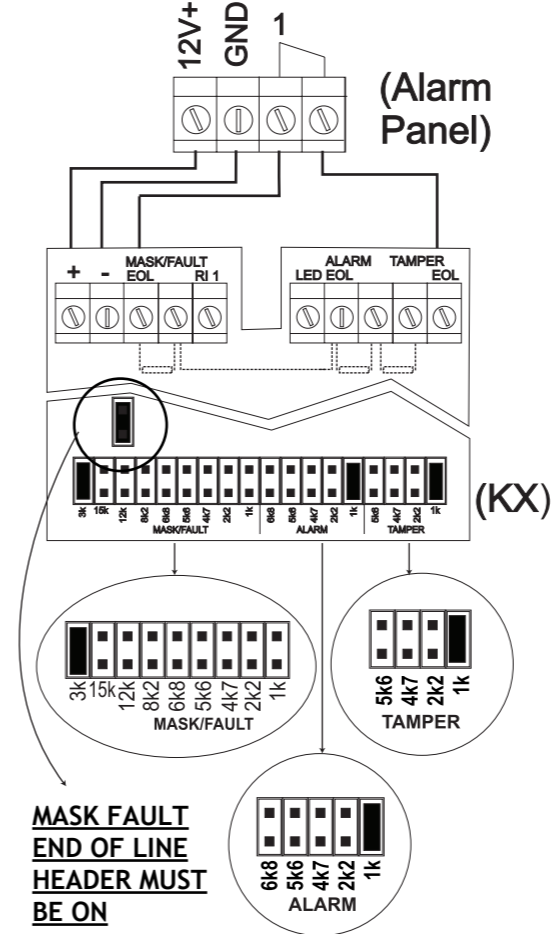

Menvier/Cooper

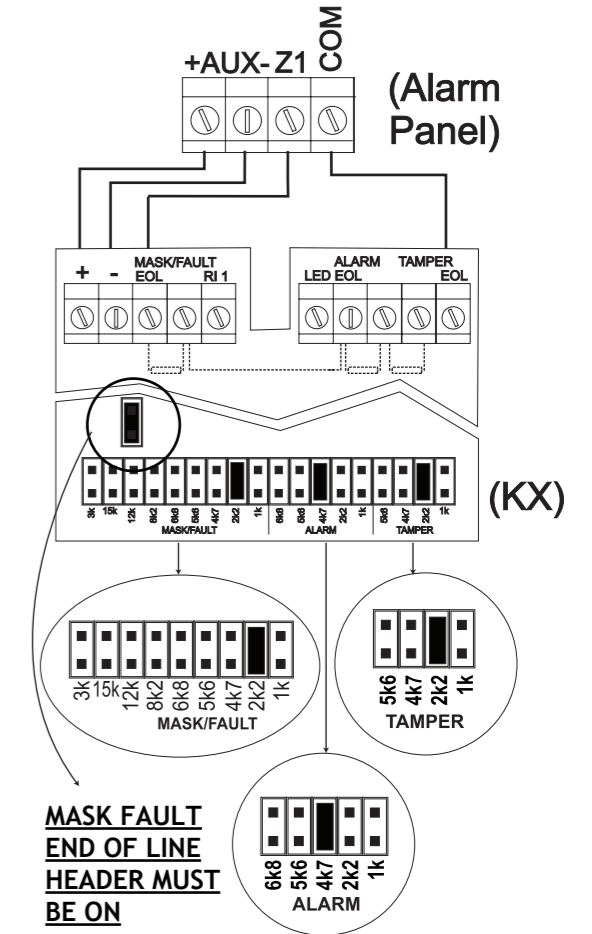

Conventional DEOL Connections: Connecting the PIR/Microwave to one input and the Anti-Masking to a separate input

Pyronix Ltd

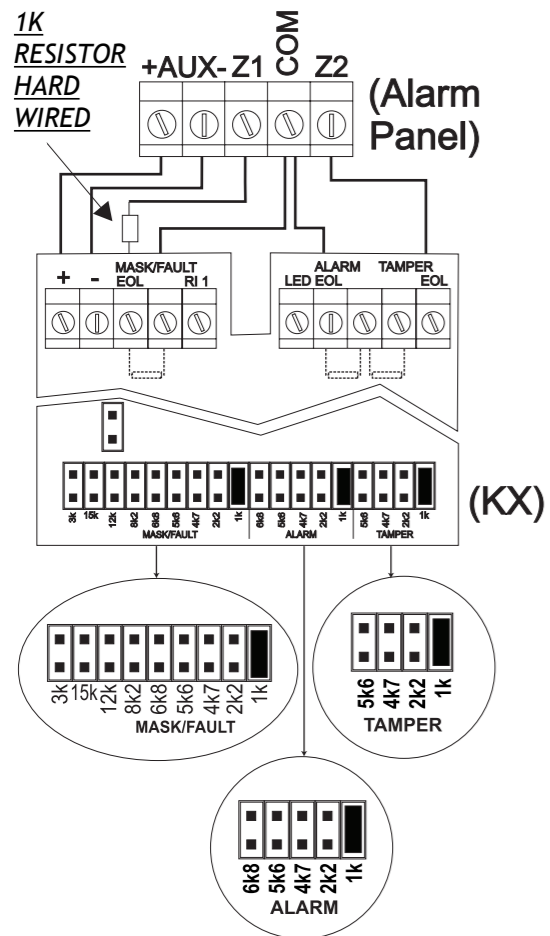

Castle

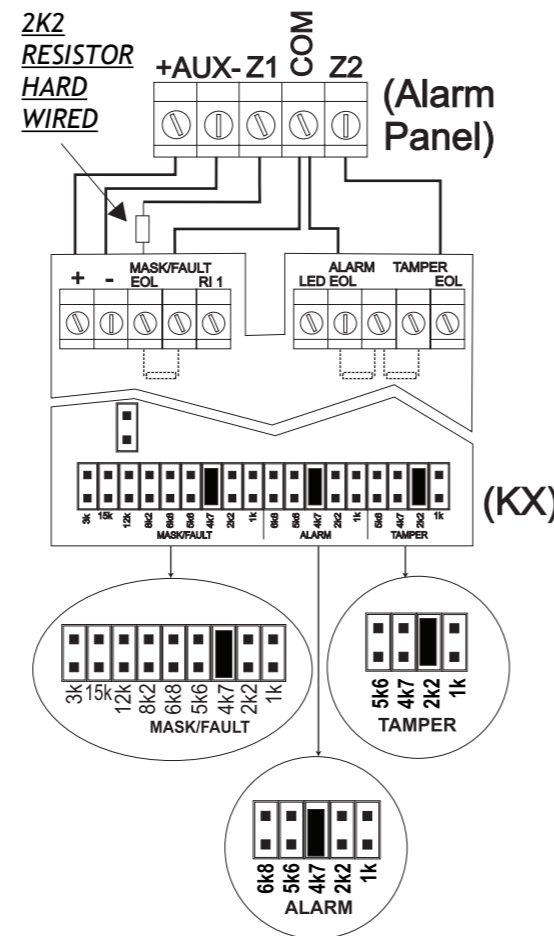

Honeywell

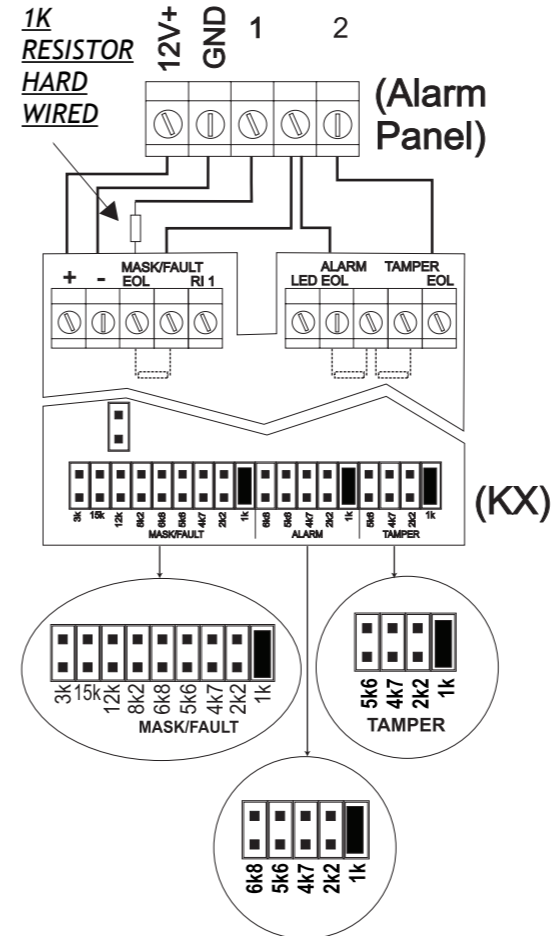

Menvier/Cooper

