

Apollo Test Set



User Manual

Contents

Safety first	3	Polling LED	39
Technical information	3	Rapid update	39
Where do I find things?	3	Soft address	39
What is the Apollo Test Set?	4	Return to factory defaults	39
How do I switch the Test Set on?	4	Sounders	41
What do I see when the Test Set is switched on?	4	Operate relays	41
How do I switch the Test Set off?	5	Soft Addressing Menu	42
How do I control the touchscreen?	5	Screen details	43
What are Device Range and Device Test Set IDs?	5	Manually set soft address	44
How do I navigate through the various menu screens?	8	Auto increment (+1) soft address	47
How do I use the Settings?	8	How do I use Loop diagnostics?	48
Screen settings	8	Short circuit fault	49
Locations	9	Earth fault	49
Cable types	10	Cable impedance and cable run	50
Setting the date and time	11	Loop supply from direction - OUT	50
Setting the language	12	Loop supply from direction - IN	51
About	12	Earth fault location search	52
How do I use the Loop View menu?	13	Loop devices map building	52
Selecting a polling range	16	Earth fault location search explained	53
Viewing the details of a single address	16	How do I enter a location?	54
Changing the output bit status	18	How do I use Stored Data?	54
Self test	18	How do you open the exported file?	56
Fast Test	19	How do I update firmware?	59
Isolator control and status	20	Troubleshooting	61
Configuration status	20	How do I do a hard reset?	61
Analogue Value / Drift	22	How do I change the Test Set battery?	61
Mode and polling LED	23	Appendix A - Menu Tree	62
Control and status	24	Appendix B - Soft Addressing	63
Events	25	Appendix C - Short circuit and earth fault detection	64
Data log	30	Appendix D - Loop supply from direction - OUT	65
How do I use Programmer mode?	36	Appendix E - Loop supply from direction - IN	66
Using the Programmer mode test buttons	37	Appendix F - Earth fault location search	67
Self test	37	Appendix G - Firmware Update	68
Fast test	37	Appendix H - Line Voltages	69
LED test	38		
Sensor status	38		
Settings	39		
Mode	39		

Apollo Fire Detectors Ltd
36 Brookside Road
Havant
Hampshire, UK
PO9 1JR

© Apollo Fire Detectors Ltd 2020



A Halma company

© Apollo Fire Detectors Ltd 2020



Safety first

- Read this User Manual completely before using the Apollo Test Set.
- The Apollo Test Set is electronic test equipment and care should be taken when handling and storing. Dropping the unit onto a hard surface could damage it.
- The Apollo Test Set is designed for indoor use only and should not be subjected to harsh environments. It is not designed for use in hazardous areas - those containing explosives or dust. Do not use the Test Set in places where temperatures and/or humidity are high or go through rapid changes.
- Do not use the Apollo Test Set if it is not operating correctly - consult the troubleshooting section or seek technical advice.
- If the Apollo Test Set is used in a manner not specified by the Manufacturer, the protection provided by the equipment may be impaired and the warranty invalidated.

Technical information

Power source	<i>Lithium-ion battery pack or 12 V Power Supply Unit</i>
Battery charging time	<i>Approx 3 hours</i>
Operating temperature	<i>0 °C to 40 °C</i>
Humidity - no condensation or icing	<i>10 to 95 % RH</i>
Dimensions	<i>215 mm x 165 mm x 50 mm</i>
Weight	<i>935 g</i>

Where do I find things?



What is the Apollo Test Set?

The Apollo Test Set is a portable test unit featuring a touch screen display capable of providing several functions in interrogating and controlling all devices connected to the unit, either individual devices or complete circuits of analogue addressable devices in the Apollo ranges (CoreProtocol®, Discovery and XP95).

The latest firmware update available for the Apollo Test Set can be downloaded by visiting the [Test Set Firmware Page](#) under **Training & Support** on our website. Or you can click here: [Firmware Update](#)

How do I switch the Test Set on?

To switch the Test Set on, press and hold the green power on button on the side of the unit. When the power LED lights up you can release the power on button.

What do I see when the Test Set is switched on?

When the Test Set is first switched on the title screen appears with a segmented circle revolving in the centre indicating that the software is being loaded. When the load is complete the Home Screen appears.



From the Home Screen you are able to access the six main menus:

- **Settings**

This menu enables you to change some of the settings of the Test Set such as the Screen settings, Location and cable type. These are explained on page 8.

- **Loop View**

The Loop View menu enables you to access a further six sub-menus. These are explained on page 13.

- **Programmer Mode**

The programmer Mode menu enables you change settings of individual devices. These are explained on page 36.

- **Soft Addressing**

The Soft Addressing menu enables you to change the address of a device. These are explained on page 42.

- **Loop Diagnostics**

The Loop Diagnostics menu enables you to troubleshoot the system and check system wiring. This is explained on page 48.

- **Location**

This enables you to enter the location. This is explained on page 54.

- **Stored Data**

This menu enables you to view stored reports, configurations, events and data logs. This is explained on page 54.

How do I switch the test set off?

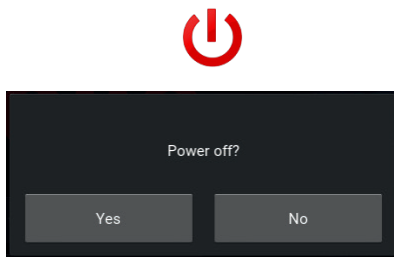

On the Home Screen, tap the 'Power Off' icon.



The 'Power-off' splash screen appears. Tap 'Yes' to power-off the unit.

How do I control the touchscreen?

The touchscreen is controlled using a finger and swiping in different directions to select items on the screen. In this User Manual the icons that follow are used to show how to move around the touchscreen.

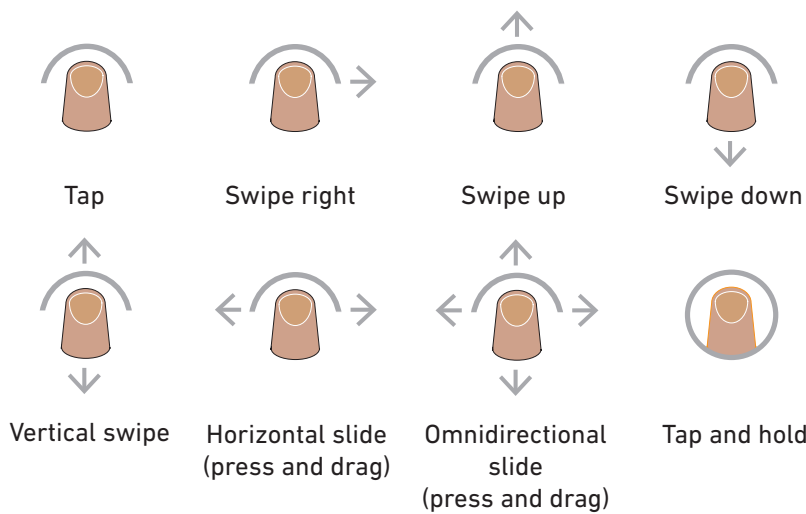

What are Device range and Device type test set IDs?

Before using the Test Set it is important that you understand the abbreviations that are used on the various screens for different device ranges and types that are used on the test set. The table that follows defines these abbreviations. It may be long but it is necessary for you to be able to understand the information being given on the screen. Each screen is divided in sections, one section for each device. Each section contains:

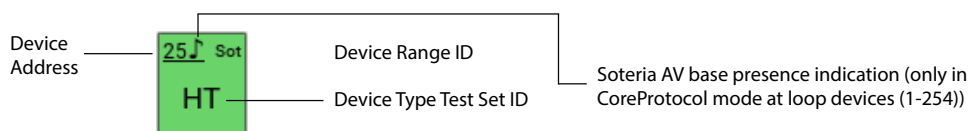

Standalone Soteria AV Bases will have *Device Type* left blank

The indication is available only in Core protocol mode at loop device (1-254) in menus Addresses, Analogue value and Drift, Mode and polling LED and Control and status. Additional to symbol ♪ green colour is used for indication.

A Soteria AV Base is indicated by ♪, any associated detector attached to the AV base is signified by *Device Type*, eg HT.

Device range ID	Range	Description
Dis	Discovery	covers all Discovery devices including Discovery UL
Sot	Soteria	all Soteria devices
XP	XP95	covers XP95, XPlover, XP95 I.S. and XPander devices
XPa	XP95A	used for XP95A devices with unique type codes
S90	Series 90	covers all Series 90 devices
U	User	covers all User type codes
Device type test set ID	Description	
SUM	Shop Unit Monitor/User Defined	
UD1	User Defined	
UD2	User Defined	
UD3	User Defined	
SND	Sounder Controller, Sounders, Visual Indicators, VADs (Base and Open Area), Sounder Control Module	
	Sounders, Visual Indicators and VADs (Base and Open Area)	
	Sounder Control Module	
	Sounder Beacon Base and Open Area	
	Sounder Base	
	Voice Sounder Beacon	
	Voice Sounder	
	Open-Area Sounder	
VAD	Reserved	
	Sounder Visual Alarm Device	
	Open-Area Sounder Visual Alarm Device	
	Visual Alarm Device Base	
VID	Open-area Visual Alarm Base	
	Sounder Visual Indicating Device	
	Open-Area Sounder Visual Indicating Base	
	Visual Indicating Device Base	
I/O	Open-Area Visual Indicating Device	
	Single Channel I/O Unit, Switch Monitor Unit, Three Channel I/O Unit and Three Channel I/O Unit (Analogue)	
	I/O Output Units and XP95A Relay Output Module	
	Input Unit (1 I/P, Faceplate and DIN-rail)	
	Output Unit (1 O/P, Faceplate and DIN-rail)	
	I/O Unit (1 I/P, 1 O/P, Faceplate and DIN-rail)	
	Mains I/O Unit (2 I/P, 1 O/P, Faceplate and DIN-rail)	
	I/O Unit (2 I/P, 2 O/P, Faceplate and DIN-rail)	
MMM	Input Unit (4 I/P, Faceplate and DIN-rail)	
	I/O Unit (4 I/P, 4 O/P, Faceplate and DIN-rail)	
SMM	Mini Switch Monitor Module and Mini Monitor Module	
	Switch Monitor Module	
ION	Switch Monitor I/O Module and 120 V I/O Module	
	Ionisation detector	
COH	CO Gaseous Fire Detector	
	CO/Heat Multisensor (without isolator)	
	CO/Heat Multisensor (with isolator)	
ZMU	UL CO Base (Apollo USA)	
	Control Unit Monitor and Zone Monitor Unit	
	Zone Monitor Unit and XPander Interface	

Device type test set ID	Description
SM	Mini Switch Monitor, Switch Monitor and Switch Monitor Plus
	Switch Monitor Plus
	Switch Monitor
ASD	Aspirating Detectors
OP	Optical detector (without isolator) and End-to-End Beam detector (EUR)
	Optical detector (without isolator)
	Optical detector (with isolator)
BD	Beam Detector (USA) and Reflective Beam detector
	Reflective Beam detector
FD	Flame detector - all types
OPH	Multisensor (Opt/Heat, without isolator)
	Multisensor (Opt/Heat, with isolator)
	Multisensor (Opt/Heat, with isolator) (Quad)
HT	Heat detector (without isolator)
	Heat detector (with isolator)
	High temperature heat detector
MCP	Manual Call Point and Manual Call Point Monitor
	Manual Call Point and Mini Switch Monitor with interrupt
	Soteria Manual Call Point without isolator
	Soteria Manual Call Point with isolator
MPS	Mini Priority Switch Monitor Module, Mini Monitor Module and Pull Station
PSM	Priority Switch Monitor Module

How do I navigate through the various menu screens?

1%	Addresses	6	7	8	9	10	11	12	13	14	15	16	24h+	100%
Home										OPH				
Addresses				HT										
Analogue value and drift														
Mode and polling LED														
Control and status														
Events				HT										
Data log														

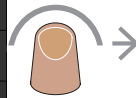

By swiping right on the left of the screen the menu selection bar appears.



Tap the menu you want to move to and the main screen changes. Tap Home to return to the Home Screen. The menu selection bar moves out of view after you have made your selection.

How do I use the Settings?

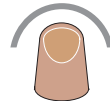

To access the Settings, tap the Settings icon on the top bar. Settings are divided into five groups:

- Screen
- Locations
- Cable types
- Date and Time
- Language

Screen settings

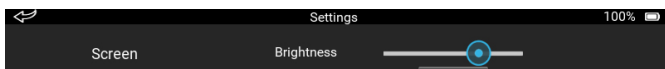

To adjust the screen brightness, press and hold the slider. Move it to the right to make the screen brighter, move it to the left to make the screen less bright.

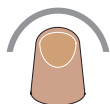
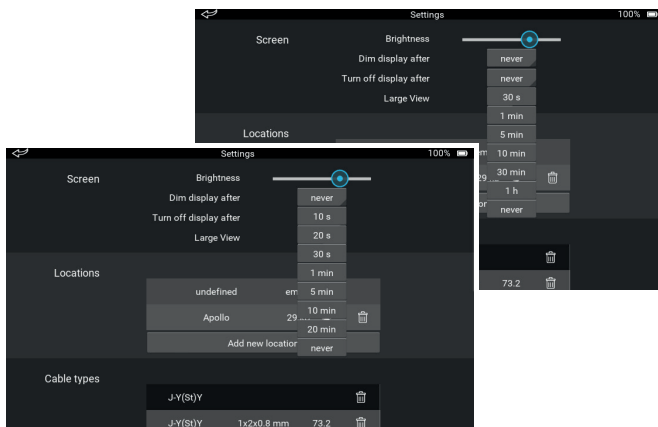

It is also possible to adjust the length of time after which the screen brightness is automatically reduced and when the display is turned off.

Tap the box next to either 'Dim display after' or 'Turn off display after'. A drop down menu appears. Tap the time that you require. The drop down menu closes.

Tap 'Large View' to increase the screen font size.

Locations

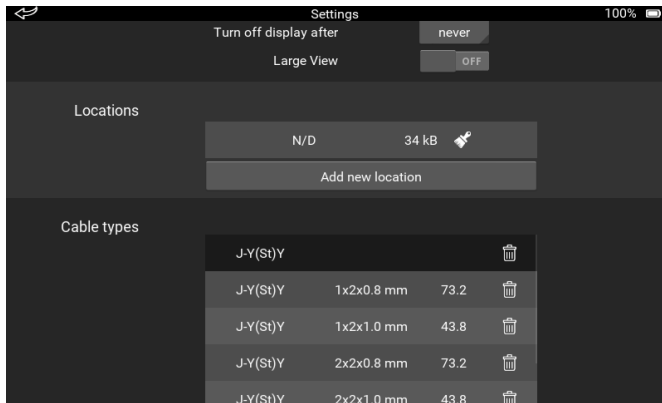

The Locations section of the Settings screen enables you to:

- Add a new location
- Remove a location from the list
- Clear all data at the selected location

Alongside the location name you will find how much memory the data is taking up and two other icons; one that looks like a brush and one that looks like a dustbin.

Default location name is N/D (not defined).

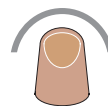
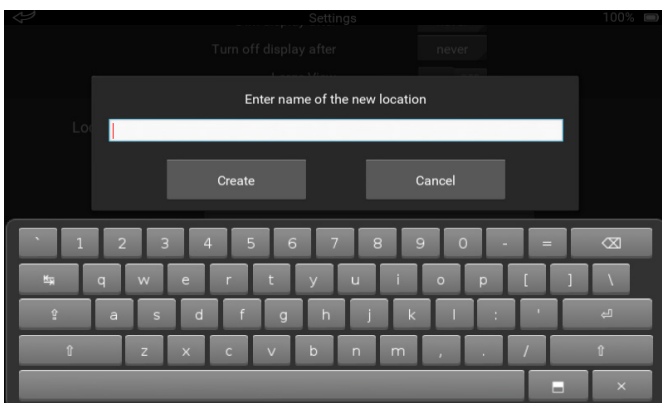

To add a new location, tap 'Add new location'. The on-screen keyboard appears. Use the keyboard to enter the name of the new location.

Tap 'OK' to return to the Settings screen.

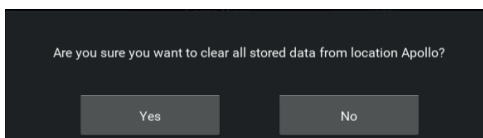

To clear stored data from a location, tap the brush icon. A splash screen appears asking you to confirm that you want to clear the data. Tap 'Yes' to clear the data.

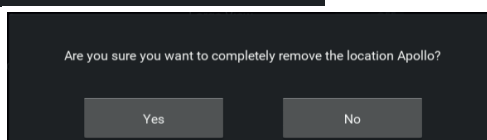

To delete the location, tap the dustbin icon. A splash screen appears asking you to confirm that you want to delete the location. Tap 'Yes' to delete the location.

Cable types



The Cable types section of the Settings screen enables you to:

- Add a new cable type to the list
- Add new dimensions to a cable type
- Remove a cable type from the list
- Remove a dimension from the list

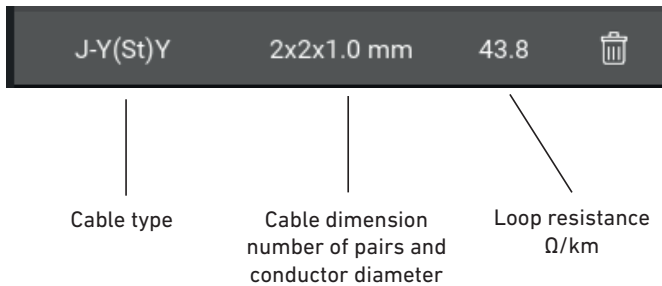

Each cable type gives additional information:

- Cable type
- Cable dimension
- Loop resistance

**Loop Resistance is total resistance through two conductors at one end of the link. That is twice the resistance of one individual conductor of that length.*

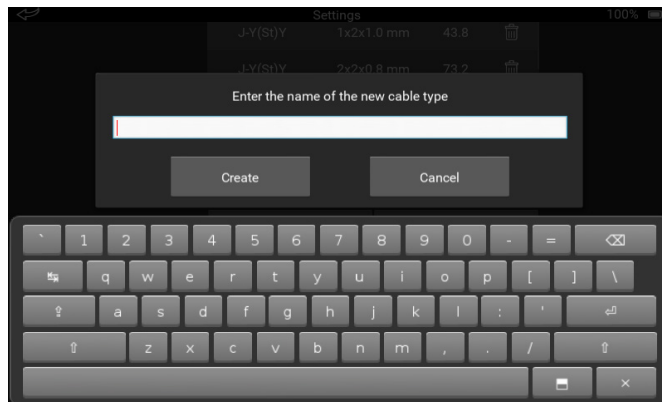

To add a new cable:

Tap 'Add new cable type'. The on-screen keyboard appears.

Enter the name for the new cable.

Tap 'Create', the new cable is added to the list.

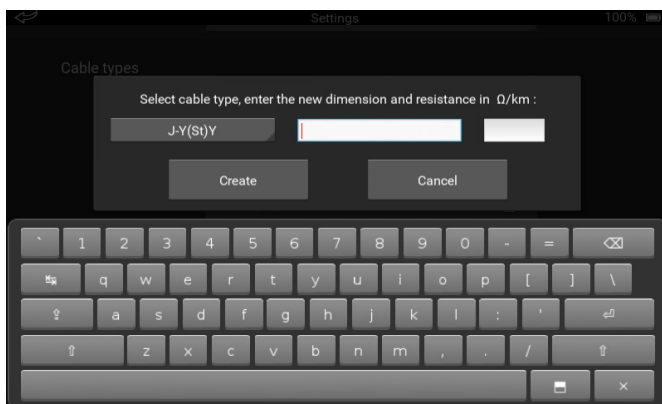

To add dimensions:

Tap to select the cable type.

Tap 'Add new dimension'. The on-screen keyboard appears.

Enter the new dimension and loop resistance. For appropriate results loop resistance (ohm/km) should be entered and not only conductor resistance.

Tap 'Create' the new dimension is added.

**It does not matter what is entered in the 'cable dimensions' box. This information is only for the user's reference.*

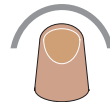
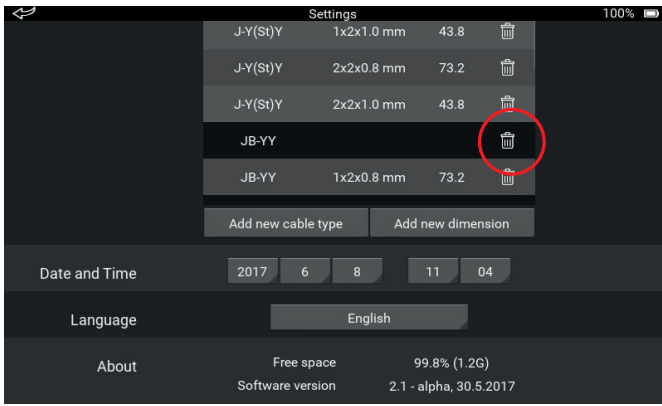

To remove a cable type from the list, tap the delete icon alongside the cable type.

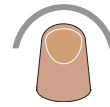
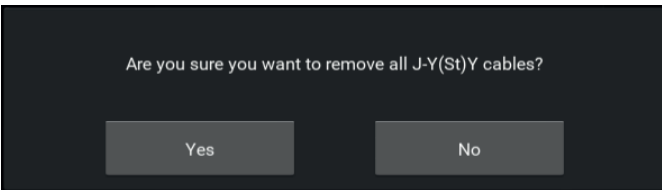

A splash screen appears asking you to confirm cable removal. Tap 'Yes', the cable type is removed.

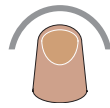
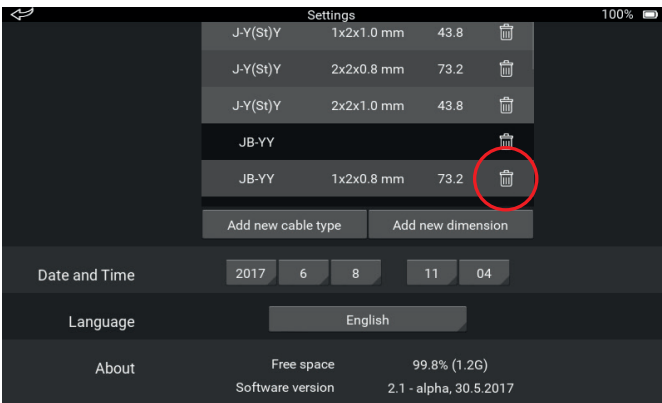

To remove a cable dimension from the list, tap the delete icon alongside the dimension.

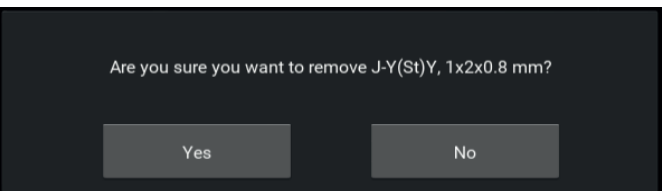

A splash screen appears asking you to confirm the dimension removal. Tap 'YES', the dimension is removed.

Setting the date and time

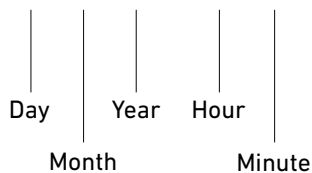
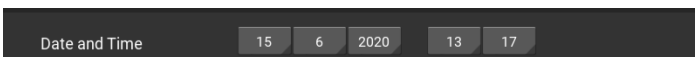

The date and time are set out as shown on the left.

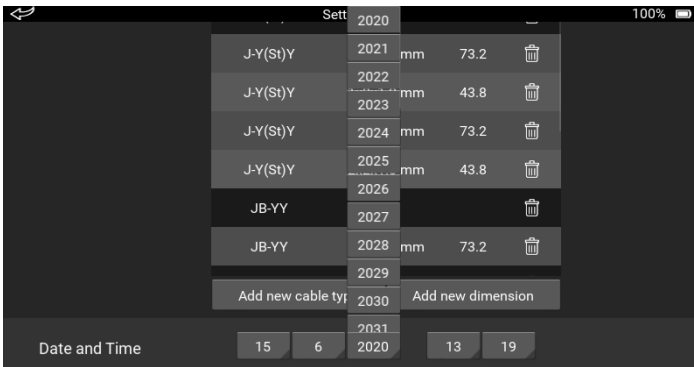

To set the date and time:

Tap each section, a drop-down menu appears. Select the required option for each section.

Setting the language

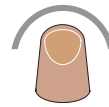

To set the language, tap the language box, a drop-down menu appears. Select the required language from the options.

The currently supported languages are English, German, Dutch, Spanish and Slovenian.

About

About	Free space	99.8% (1.1G)
	Software version	1.012, 12.11.2017
	Firmware version	1.0

The About section of the Settings screen shows:

- Free disc space (percentage and actual)
- Version of software installed
- Version of firmware installed

How do I use the Loop View menu?

When using the Loop View menu the device status is indicated using the colours that follow:

Corrupt data	Empty address	Dual address	Analogue value ≤ 8	$8 <$ analogue value ≤ 44	$45 \leq$ analogue value ≤ 54	Analogue value ≥ 55	Drift Value	Not polled

** small rectangle with a black number and coloured background (background colour depends on the value of drift in %) - used only in Analogue Value / Drift Sub-menu.*



On the Home Screen tap the Loop View tab.

The address scan screen appears. It shows all of the allocated addresses on the loop and their status.

By default the Test Set uses the XP95/Discovery protocol. If it is a CoreProtocol loop that you are working on you need to change the protocol as follows.



At the top of the address scan screen swipe down. The top bar appears. It contains several icons, but the one we need is the protocol change icon. The active protocol is highlighted in orange.

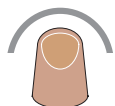
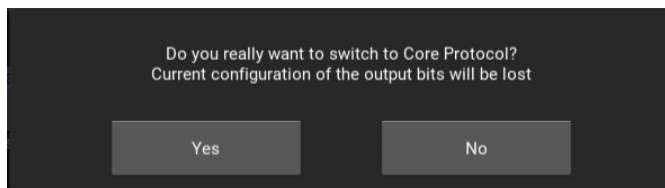

Tap the protocol change icon. A warning screen appears. Tap 'Yes' - XP95/Discovery will change to grey and CoreProtocol will change to orange. The protocol change is now complete.

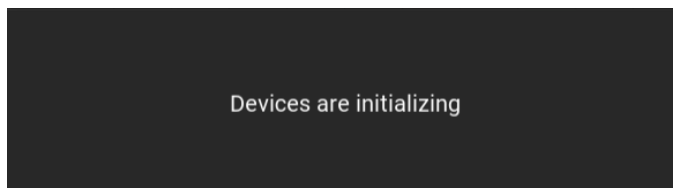

After 'Yes' the first informative message appears 'Devices are initializing'.

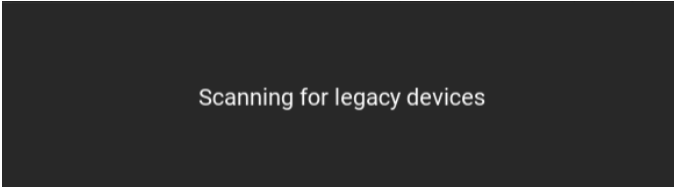

The second informative message appears 'Scanning for legacy devices' and the XP95 / Discovery will change to grey.

Whilst we are talking about the top bar lets see what the other icons mean:



Direction enabled (yellow)/disabled (grey) - tap to change the current status



Voltage 28 V/35 V - tap the icon to switch voltages (CoreProtocol only) - see below



Sounder synchronisation - tap to synchronise sounders



Tap to save Loop Report/Loop configuration (only available in Control and Status - Mode and Polling LED)



Loop health - calculation based on received data (address confirmation, a parity bit and checksum)

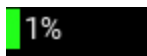

Loop noise - this is a calculation based on current pulse amplitude

Noise level (%)	Meaning
0	Theoretical minimum
4	Clean installation
36	Good installation in an industrial environment
80	Bad installation (segregation, multiple address loops on the same cable, bad junction points) or long installation in a very severe industrial environment
100	Very bad installation (earth fault, bad junction points, crosstalk)

Acceptable value is a value below 80%



Absolute polling range - the total number of devices with the same status. Colours are defined on page 8.

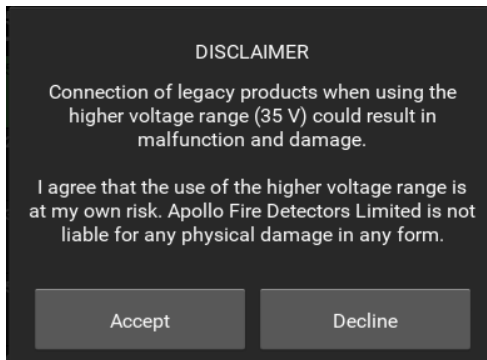

To change voltage range, tap the Voltage icon. The message 'Loop Scanning' appears. If changing voltage is possible, the Disclaimer splash screen appears. Tap 'Accept' to change voltage.

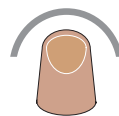

If a voltage change is not possible, the message 'Switching to 35 V is not possible' appears.

**Voltage change is not possible when one or more XP95 or Discovery devices are fitted on the loop.*

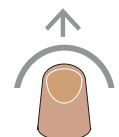

To close the top bar, swipe up.

With the basics of the Loop View menu covered, let's do a few tasks:

Selecting a polling range

Addresses																OUT	IN	XP95/Discovery	24h+	100%	
1	2	3	4	5	6	7	8	9	10	11	12	13	14	15	16						
OPH	MCP	OPH	SND	OPH	MCP					MCP			OPH								
17	18	19	20	21	22	23	24	25	26	27	28	29	30	31	32						
			SND					HT													
33	34	35	36	37	38	39	40	41	42	43	44	45	46	47	48						
OP				OP				OPH													
49	50	51	52	53	54	55	56	57	58	59	60	61	62	63	64						
65	66	67	68	69	70	71	72	73	74	75	76	77	78	79	80						
81	82	83	84	85	86	87	88	89	90	91	92	93	94	95	96						
97	98	99	100	101	102	103	104	105	106	107	108	109	110	111	112						
								HT													
113	114	115	116	117	118	119	120	121	122	123	124	125	126								
											HT										

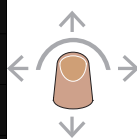

To select a range of addresses to be polled, press and hold at the starting address, then slide your finger to the finishing address. The selected polling range is highlighted on the screen.

Polling Soteria AV bases

(*) This option is available only in CoreProtocol mode.

When CoreProtocol window opens (in all menus) two tabs appear at the top of the addresses net. The first one presents loop devices and the second one the AV bases.

Addresses																OUT	IN	CoreProtocol	28 V	24h+			
Loop devices																AV bases							
1	2	3	4	5	6	7	8	9	10	11	12	13	14	15	16								
SND	OP					SND	SND		SND	SND					OP								
17	18	19	20	21	22	XP	23	24	25	26	27	XP	28	29	30	31	32						
					SND	SND			VID	MCP				HT	HT								
33	34	35	36	37	38	39	40	41	42	43	44	45	46	47	48								
					OP							SND	VAD	VID	VAD								
49	50	51	52	53	54	55	56	57	58	59	60	61	62	63	64								
VID																							
65	66	67	68	69	70	71	72	73	74	75	76	77	78	79	80								
81	82	83	84	85	86	87	88	89	90	91	92	93	94	95	96								
97	98	99	100	101	102	103	104	105	106	107	108	109	110	111	112								

Loop devices – when this tab is selected the addresses between 1 and 254 are polling (polling range)

AV bases – when this tab is selected the Loop View displays only Soteria AV Bases installed on the loop.

Indication

The device is selected when the extended blue line, above the tab, is in use.

Switching between polling ranges

Tap on the tab needed to switch between either options. An informative message appears on the screen 'Getting screen ready ...'. When the message disappears, the selected polling range is used for polling.

Addresses																OUT	IN	CoreProtocol	28 V	24h+			
Loop devices																AV bases							
1	2	3	4	5	6	7	8	9	10	11	12	13	14	15	16								
SND	OP					SND	SND		SND	SND					OP								
17	18	19	20	21	22	XP	23	24	25	26	27	XP	28	29	30	31	32						
					SND	SND			VID	MCP				HT	HT								
33	34	35	36	37	38	39	40	41	42	43	44	45	46	47	48								
					OP							SND	VAD	VID	VAD								
49	50	51	52	53	54	55	56	57	58	59	60	61	62	63	64								
VID																							
65	66	67	68	69	70	71	72	73	74	75	76	77	78	79	80								
81	82	83	84	85	86	87	88	89	90	91	92	93	94	95	96								
97	98	99	100	101	102	103	104	105	106	107	108	109	110	111	112								

Getting screen ready ...

Viewing the details of a single address

To see the details of a particular address:

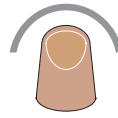

On the address scan screen, tap the device that you want to see the detail of. The single address splash screen appears

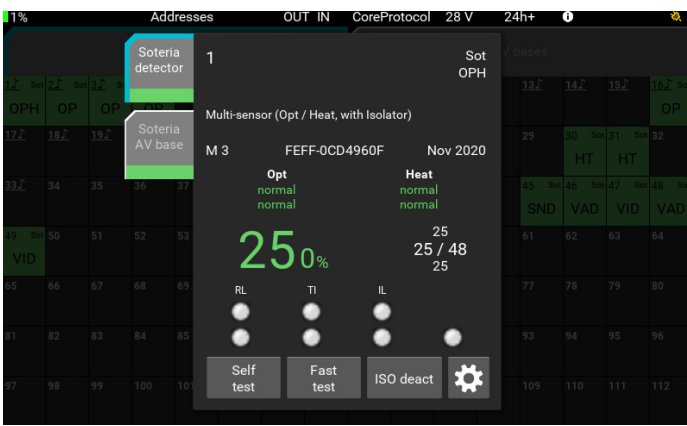

The single address splash screen gives information on:

Single address tabs

Single address tabs display the status of loop device (upper tab) (1-254) and Soteria AV base (1025-1278) (* only available in Core protocol mode).

The device can be selected with a tap on the tab.

Indication

The device is selected when the extended blue line is used.

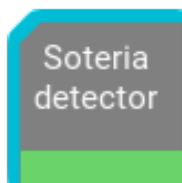

Selected loop device



Unselected Soteria AV base

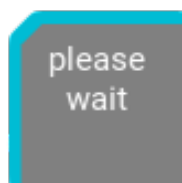

When entering single address view on both tabs text **'please wait'** is displayed for a short time (the application is acquiring the data).

Loop Device

Device Status - standard colour model for device state is used.

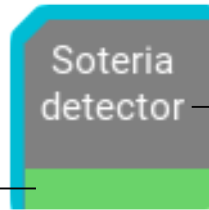

Device Type - if Soteria detector is used then *Soteria detector* is displayed, otherwise device range and device type are displayed.



Example without Soteria Detector



Empty Address

Soteria AV Base

Device Status - standard colour model for device state is used.

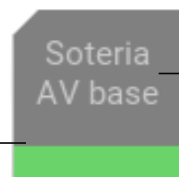

Device Type - if *Soteria AV base* is displayed, then device is available, if *No Device* is displayed then address is empty. If at the basic layer any other device is fitted then Soteria detector *No Pairing* is displayed.



Pairing Disabled

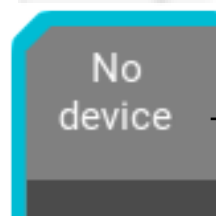

No Device

The single address splash screen gives information on:

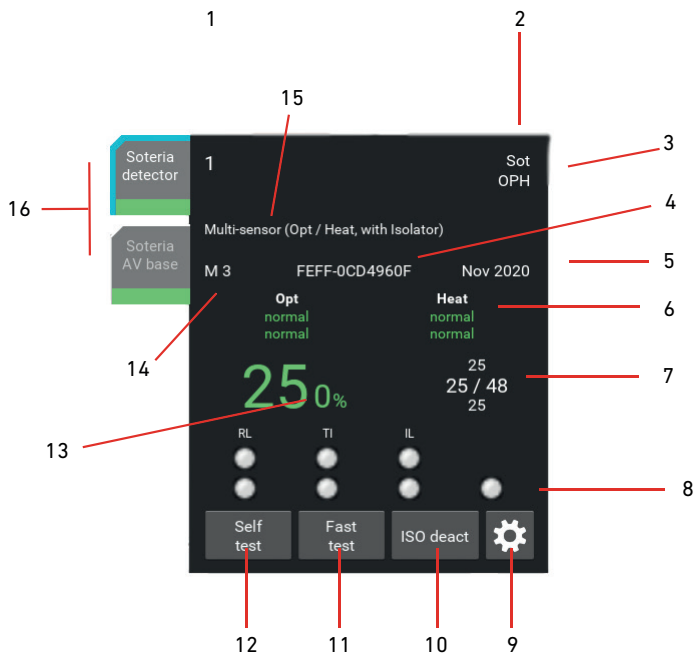

Key

- 1 Device address
- 2 Range ID - see page
- 3 Device type test set ID - see page
- 4* Serial Number in HEX XXXX-XXXXXXXX (MSB to LSB)
- 5 Manufacture date - first three letters of month, year
- 6* Sensor status - first row, sensor type, second row live sensor status, third row last sensor status. Blue - fault, Green - normal, Orange - active, Red alarm
- 7 Analogue value - max/min/average
- 8 Input/Output status. Top row - bit name - see page 10, Middle row - output bit status, Bottom row - input bits status. Red -On, Grey - Off
- 9** Configuration status
- 10** Isolator control
- 11 Fast Test - tab only enabled for devices that allow fast test
- 12 Self Test - tab only enable for devices that allow self test
- 13 Drift in %
- 14*** Detection Mode
- 15 Description of device type
- 16**** Device status tab - top, loop device / down, Sotera AV base

* Sotera devices only ** Sotera devices that allow this option only *** Discovery and Sotera devices only ****only in CoreProtocol Mode

Abbreviation	Output bit name
AL	Alarm Load Simulation
BO	Beacon On
CO	Continuous Output
DL	Detector LED
EV	Evacuate
FS	Fault Simulation
GA	Group Addressing
IL	Internal LED
NU	Not Used
OI	Opto-Isolated Output
OR	Output Relay
PO	Pulsed Output
RL	Remote LED
RO	Remote ON
RS	Reset
SO	Sounder ON
TI	Test Initiated

Changing the output bit status



To change the output bit status of a particular device, tap on the required address, the single address splash screen appears.

Tap the output bit icon that you want to change the status of.

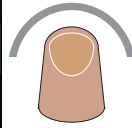

ON



OFF



To close the single address splash screen, tap on the main screen to the left of it.

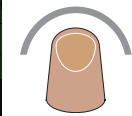

However, for details of self test, fast test, isolator control and configuration settings - read on.

Self test

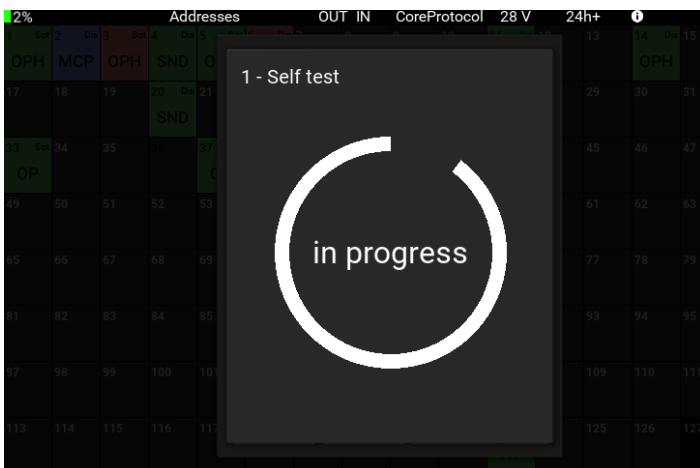

Tap the Self Test button, the self test is activated immediately. The circle represents a countdown timer which is set at 20 seconds. If the analogue value increases to 55 before the timer expires, a 'Pass' splash screen appears, otherwise a 'Fail' splash screen appears.

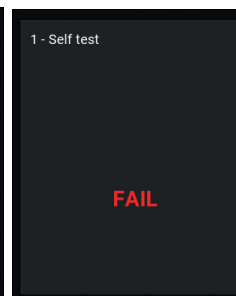
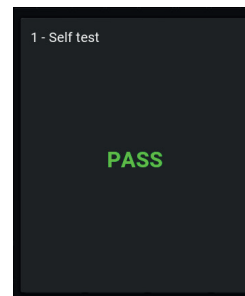

If you want to stop the self test, or close the splash screen after the test, just tap on the main screen, to the left of it.

Fast Test

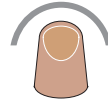
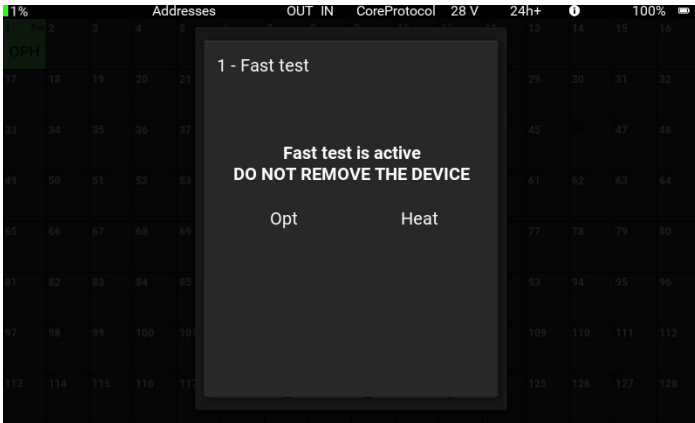

Tap the Fast Test button, the fast test is activated immediately. If a fast test cannot be done - a message 'Fast test cannot be performed' appears and the splash screen returns to the single address view.

If the message shown on the left appears, the fast test is active and you should apply smoke or heat to the detector as appropriate.

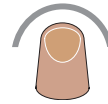
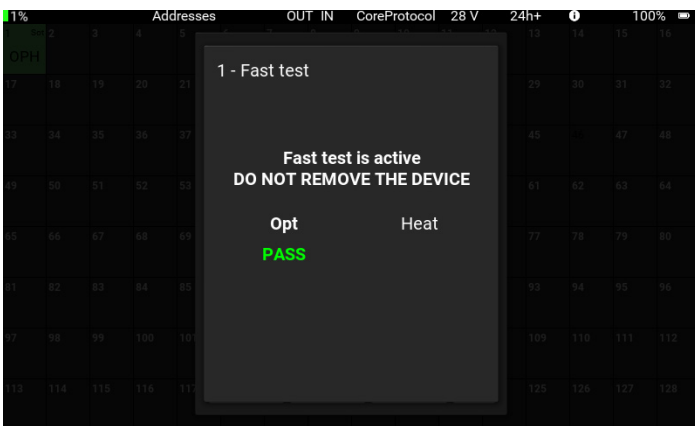

When the sensor in the detector has entered alarm, the green 'Pass' text will appear and the sensor name changes to green. The sensor name remains green until the analogue value returns to its initial value, the sensor name then changes to white.

To stop the test or close the Fast Test splash screen, tap on the main screen to the left of it. The data restore operation starts.



(a)

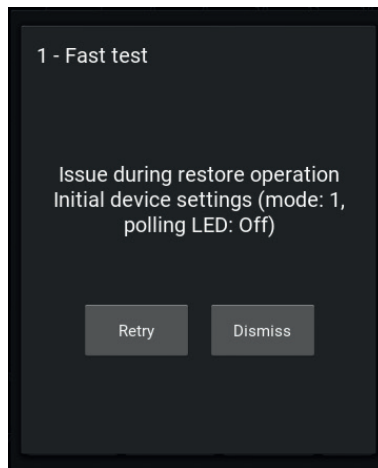

(b)

If the device successfully passes the data restore operation, the 'Data restored' splash screen (a) appears. If the data restore is not successful the 'Issue during restore operation' splash screen appears along with details of the initial device settings (mode, polling LED status). Tap either 'Retry' or 'Dismiss' as appropriate.

'Retry' will start the test again. 'Dismiss' closes the Fast Test splash screen.

Isolator control and status



If the device has an option to control the isolator (some Soteria devices), then this button is used as a toggle button to activate or deactivate the isolator.

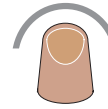

Otherwise, it is used as an isolator status indicator (Discovery devices). In some cases, if the device does not have an isolator, this button is disabled.

Configuration status

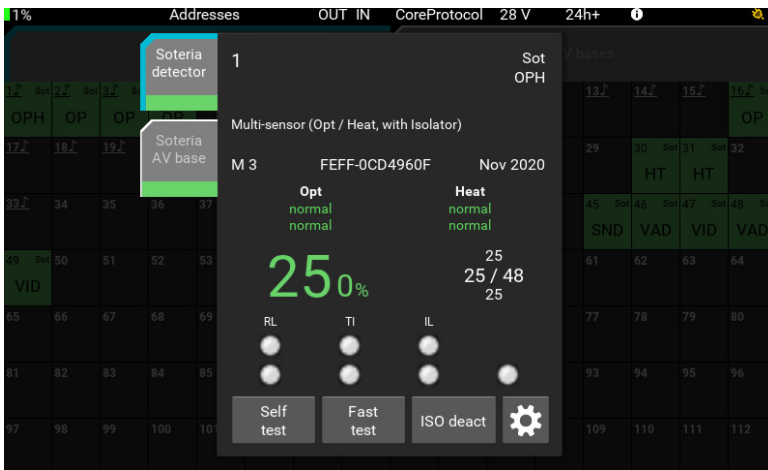

Tap the Configuration Status button to show the configuration status of any Soteria device on the loop. The Configuration Status splash screen appears.

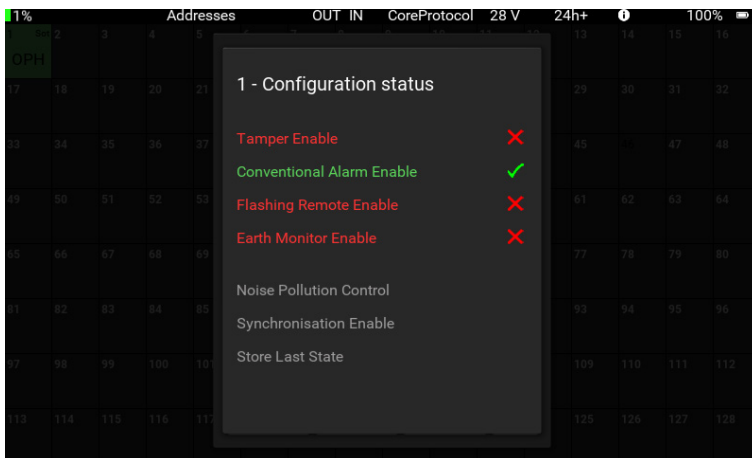
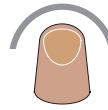

Configuration can be checked for Soteria devices and Discovery sounders. White text and a tick shows the item is enabled. Red text and a cross shows the item is disabled. Tap anywhere outside of the splash screen to close it and return to the single address splash screen.

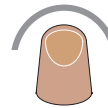

**note: that the status cannot be changed, you can only check the status.*

Configuration status features and their meaning:

Feature	Description
Tamper Enable	enabled (✓) / disabled (x) / not available (Tamper Enable)
Conventional Alarm Enable	enabled (✓) / disabled (x) / not available (Conventional Alarm Enable)
Flashing Remote Enable	enabled (✓) / disabled (x) / not available (Flashing Remote Enable)
Earth Monitor Enable	enabled (✓) / disabled (x) / not available (Earth Monitor Enable)
Noise Pollution Control	enabled (✓) / disabled (x) / not available (Noise Pollution Control)
Synchronisation Enable	enabled (✓) / disabled (x) / not available (Synchronisation Enable)
Store Last State	enabled (✓) / disabled (x) / not available (Store Last State)

Configurations for Soteria devices are shaded blue, while, configurations for Discovery sounders are shaded yellow.

Analogue Value/Drift

This menu enables you to view the analogue value and drift in % of the devices on the loop.

1%	Addresses	6	7	8	9	10	11	12	13	14	15	16
Home										OPH		
Addresses		22	23	24	25	26	27	28	29	30	31	32
Analogue value and drift					HT							
Mode and polling LED		38	39	40	41	42	43	44	45	46	47	48
Control and status		54	55	56	57	58	59	60	61	62	63	64
Events		70	71	72	73	74	75	76	77	78	79	80
Data log		86	87	88	89	90	91	92	93	94	95	96
		102	103	104	105	106	107	108	109	110	111	112
		118	119	120	121	122	123	124	125	126		
							HT					

 Swipe right from the left side of the screen. The menu selection bar appears.

 Tap 'Analogue value/Drift'. The menu selection bar closes and the Analogue value and Drift screen appears.

2%	Analogue value and drift	OUT	IN	XP95/Discovery	24h+	100%																									
1	OPH 25 0%	2	MCP 4	3	OPH 25 0%	4	SND 23	5	OPH 25 0%	6	MCP 64	7		8		9		10		11	MCP 16	12		13		14	OPH 25 0%	15		16	
17		18		19		20	SND 23	21		22		23		24		25	HT 25 0%	26		27		28		29	OPH 25 0%	30		31		32	
33	OPH 25 0%	34		35		36		37	OPH 25 0%	38		39		40		41	OPH 25 0%	42		43		44		45	OPH 25 0%	46		47		48	
49		50		51		52		53		54		55	OPH 25 0%	56		57		58		59		60		61		62	OPH 25 0%	63		64	
65		66		67		68		69	OPH 25 0%	70		71		72		73		74		75		76		77		78		79		80	
81		82		83		84		85		86		87		88		89		90		91		92		93		94		95		96	
97		98		99		100		101		102		103		104		105	HT 25 0%	106		107		108		109		110		111		112	
113		114		115		116		117		118		119		120		121		122		123	HT 25 0%	124		125		126					

The Analogue value and Drift values for each of the devices is shown.

Each device shows the information that follows:

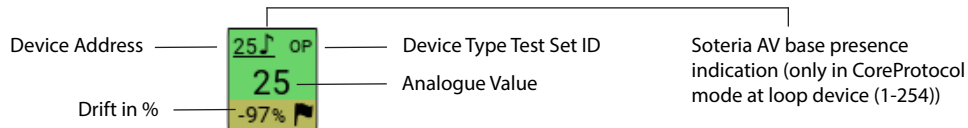

Note: In the case of Series 90, XP95 devices and certain Discovery and Soteria devices (MCP, I/O and SM) drift value is not shown.

Below is the Drift in % colour chart. This gives a quick indication on the level of drift.

Drift value	0	1	2	3	4	5	6	7	8	9	10	11	12-20	21	22	23	24	25	26	27	28	29	30	31
Drift Flag	1	1	1	1	0	0	0	0	0	0	0	0	0	0	0	0	0	0	0	0	0	0	0	1
Drift in %	-100	-97	-95	-93	-85	-78	-67	-56	-44	-33	-22	-11	0	9	18	27	36	45	55	64	73	82	90	100

Mode and polling LED

This menu enables you to see the mode and LED status of the devices on the loop.

1%	Addresses	6	7	8	9	10	11	12	13	14	15	100%
Home										OPH		
Addresses				HT								
Analogue value and drift												
Mode and polling LED												
Control and status												
Events				HT								
Data log												

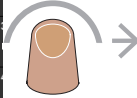

Swipe right from the left side of the screen. The menu selection bar appears.

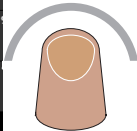

Tap 'Mode and Polling LED'. The menu selection bar closes and the Mode and Polling screen appears.

1%	Mode and polling LED	6	7	8	9	10	11	12	13	14	15	100%
1	OPH	M 15	M 3	M 71	M 3	M 15						
17												
33												
49												
65												
81												
97												
113												

The mode and LED status for each device is shown.

Each device shows the information that follows:

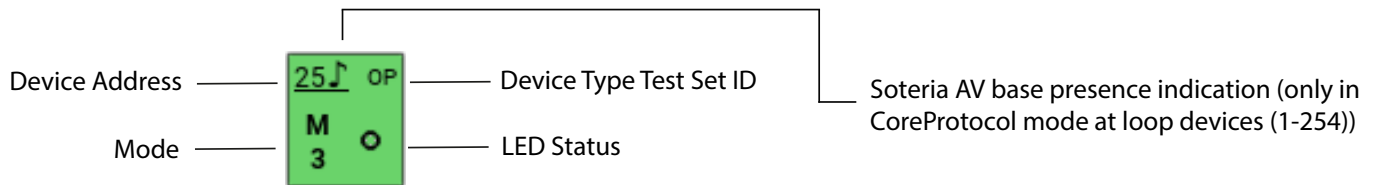

Note: In the case of Series 90 and XP devices the mode and LED status will be blank.

The mode and status information shows:

- M 2 Device mode (in this instance Mode 2)
- LED status (if this section is empty the status is not available)
- LED off
- ☀ LED on

Control and Status

This menu enables you to view the current status of input and output bits.

1%	Addresses	6	7	8	9	10	11	12	13	14	15	100%
Home										OPH		
Addresses					HT							
Analogue value and drift												
Mode and polling LED												
Control and status												
Events					HT							
Data log									HT			

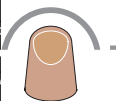

Swipe right from the left side of the screen. The menu selection bar appears.



Tap 'Control and Status'. The menu selection bar closes and the Control and Status screen appears.

1%	Control and Status	OUT	IN	XP95/Discovery	24h+	100%
1	OP					
2	SM					
3	SM					
4	SM					
5						
6	I/O					
7	MCP					
8						
9	NN					
10						
11						
12						
13	I/O					
14						
15						
17						
18						
19						
20						
21						
22						
23						
24						
25						
26						
27						
28						
29						
30						
31						
33						
34						
35	SM					
36						
37						
38						
39						
40						
41						
42	SND					
43						
44						
45						
46						
47						
49						
50						
51						
52						
53						
54						
55						
56						
57						
58						
59						
60						
61						
62						
63						
65						
66						
67						
68						
69						
70						
71						
72						
73						
74						
75						
76						
77						
78						
79						
81						
82						
83						
84						
85						
86						
87						
88						
89						
90						
91						
92						
93						
94						
95	I/O					
97						
98						
99						
100						
101						
102						
103						
104						
105						
106						
107	I/O					
108						
109						
110						
111						
113	I/O					
114						
115						
116						
117						
118						
119						
120	OP					
121						
122						
123	HT					
124						
125						
126	OP					

The current status of input and output bits for each device is shown.

Each device shows the information that follows:

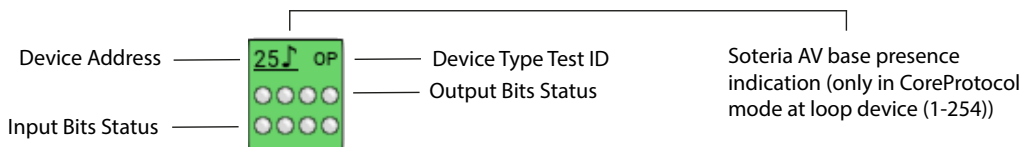

Note: In the case of an empty address only the status of output bits is shown.

The input/output bits status icons are:



If there is no status icon the information is not available

Events

In this sub-menu event flags and event types are displayed. When the **Events** sub-menu is selected, the application starts recording (flashing red LED (•) in the title bar) all events that occur. Different colours indicate the type of the event (alarm, fault, tamper) or device status (dual address, empty address, occupied address).

Occupied address	Empty address	Dual address	Tamper*	Alarm*	Fault*
------------------	---------------	--------------	---------	--------	--------

Note: * indicates the event on the device at the given address

Home	6	7	8	9	10	11	12	13	14	15	16
Addresses	22	23	24	25	26	27	28	29	30	31	32
Analogue value and drift	38	39	40	41	42	43	44	45	46	47	48
Mode and polling LED	54	55	56	57	58	59	60	61	62	63	64
Control and status	70	71	72	73	74	75	76	77	78	79	80
Events	86	87	88	89	90	91	92	93	94	95	96
Data log	102	103	104	105	106	107	108	109	110	111	112
	118	119	120	121	122	123	124	125	126		

Swipe right from the left side of the screen. The menu selection bar appears.

Tap 'Events'. The menu selection bar closes and the Events screen appears.

1	OP	2	OP	3	OP	4	OP	5	OP	6	OP	7	OP	8	OP	9	OP	10	OP	11	OP	12	OP	13	OP	14	OP	15	OP	16
17	OP	18	OP	19	OP	20	OP	21	OP	22	OP	23	OP	24	OP	25	OP	26	OP	27	OP	28	OP	29	OP	30	OP	31	OP	32
33	OP	34	OP	35	OP	36	OP	37	OP	38	OP	39	OP	40	OP	41	OP	42	OP	43	OP	44	OP	45	OP	46	OP	47	OP	48
49	OP	50	OP	51	OP	52	OP	53	OP	54	OP	55	OP	56	OP	57	OP	58	OP	59	OP	60	OP	61	OP	62	OP	63	OP	64
65	OP	66	OP	67	OP	68	OP	69	OP	70	OP	71	OP	72	OP	73	OP	74	OP	75	OP	76	OP	77	OP	78	OP	79	OP	80
81	OP	82	OP	83	OP	84	OP	85	OP	86	OP	87	OP	88	OP	89	OP	90	OP	91	OP	92	OP	93	OP	94	OP	95	OP	96
97	OP	98	OP	99	OP	100	OP	101	OP	102	OP	103	OP	104	OP	105	OP	106	OP	107	OP	108	OP	109	OP	110	OP	111	OP	112
113	OP	114	OP	115	OP	116	OP	117	OP	118	OP	119	OP	120	OP	121	OP	122	OP	123	OP	124	OP	125	OP	126				

The event status of each device is shown.

Each device shows the information that follows:

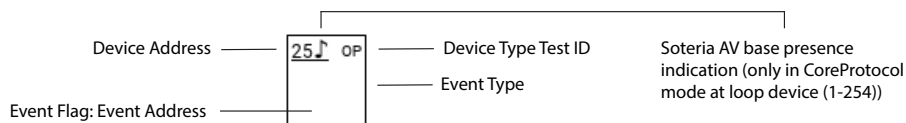

Examples of the event types, event flag: event address are:

	Description	Text on screen
Event	Alarm, MCP alarm	Alarm
	Fault	Fault
	Tamper	Tamper
Event flag: event address	The device at the address 10 placed an alarm bit	A:10
	The device at the address 1 placed an interrupt bit	I:1

Top Bar Menu

In this top bar - function for sounder synchronisation is not used. It also differs from other top bars in the presentation of loop review.



Top Bar Loop Review



first number – absolute polling range,

next four numbers – the sum of all devices with the same status

last three numbers – the sum of all events occurred on the loop separated into three groups (MCP alarms, alarms and other events (tamper, fault))

Single Address States

To access Single address states, tap the desired address field. To close Single address states view, tap anywhere on the screen.

1	OP	2	OP	3	OP	4	OP	5	OP	6	OP	7	OP	8	OP	9	OP	10	11	12	13	14	15	16
17	18	19	20	21	22	23	24	25	26	27	28	29	30	31	32									
33	34	35	36	37	38	39	40	41	42	43	44	45	46	47	48									
49	50	51	52	53	54	55	56	57	58	59	60	61	62	63	64									
65	66	67	68	69	70	71	72	73	74	75	76	77	78	79	80									
81	82	83	84	85	86	87	88	89	90	91	92	93	94	95	96									
97	98	99	100	101	102	103	104	105	106	107	108	109	110	111	112									
113	114	115	116	117	118	119	120	121	122	123	124	125	126											

States of address 7

Normal 2 1 1 0 0 0 0 MCP Alarm Other

0 0 0

17	18	19	20	21	22	23	24	25	26	27	28	29	30	31	32
				Time				State							
				13:09:11				Normal							
				13:09:04				Pre-alarm							
33	34	35	36	13:08:25				Alarm				45	46	47	48
				13:08:05				Normal							

The meaning of the inscriptions:

States of address 7

selected address

Normal

real-time state of selected address



the sum of all event flags occurred at selected address

Time	State
13:09:11	Normal
13:09:04	Pre-alarm
13:08:25	Alarm
13:08:05	Normal

chronological list of state changes at selected address

Scrolling among states at the same address:

Time	State
13:09:11	Normal
13:09:04	Pre-alarm
13:08:25	Alarm
13:08:05	Normal

Scrolling among addresses:

Higher address:

Time	State
13:09:11	Normal
13:09:04	Pre-alarm
13:08:25	Alarm
13:08:05	Normal

Lower address:

Time	State
13:09:11	Normal
13:09:04	Pre-alarm
13:08:25	Alarm
13:08:05	Normal

Loop Events List

To access Loop events list, tap the area where the event flags are shown. To close the current view, tap anywhere on the screen.

1	2	3	4	5	6	7	8	9	10	11	12	13	14	15	16
OP	OP	OP	OP	OP	OP	OP	OP	OP	OP	OP	OP	OP	OP	OP	OP
						Alarm									
17	18	19	20	21	22	23	24	25	26	27	28	29	30	31	32
33	34	35	36	37	38	39	40	41	42	43	44	45	46	47	48
49	50	51	52	53	54	55	56	57	58	59	60	61	62	63	64
65	66	67	68	69	70	71	72	73	74	75	76	77	78	79	80
81	82	83	84	85	86	87	88	89	90	91	92	93	94	95	96
97	98	99	100	101	102	103	104	105	106	107	108	109	110	111	112

Time	Address	Flag	Event address	Event type
13:08:31	126	alarm	7	Alarm
13:08:30	110	alarm	7	Alarm
13:08:29	94	alarm	7	Alarm
13:08:29	78	alarm	7	Alarm
13:08:28	62	alarm	7	Alarm
13:08:27	46	alarm	7	Alarm
13:08:26	30	alarm	7	Alarm
13:08:25	14	alarm	7	Alarm
13:08:24	124	alarm	7	Alarm
13:08:23	108	alarm	7	Alarm
13:08:23	92	alarm	7	Alarm



the timestamp of the event

address where a flag occurred

address

selected address

selected address

The meaning of the parameters:

Flag	Event Type
alarm	Alarm Fault
interrupt	MCP Alarm

Saving Events

To save recorded events:



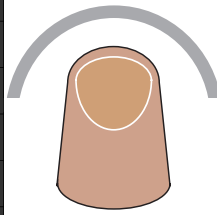

Tap one of the available options (sub-menus).

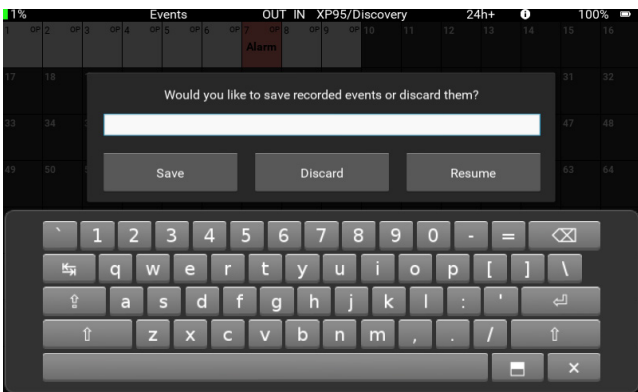

Enter the file name in the dialog box.

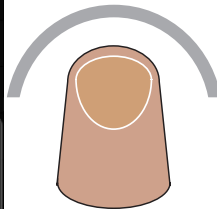
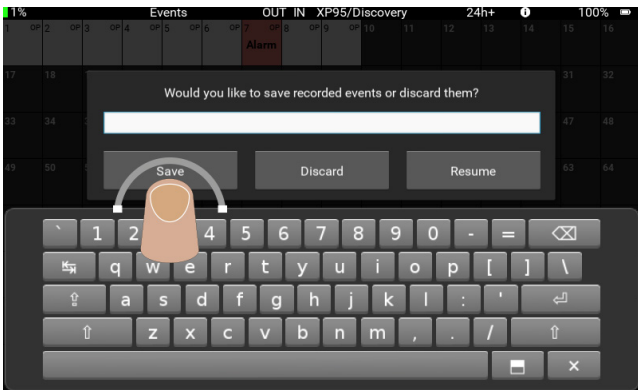

Confirm saving by tapping the 'Save' button.

The file is saved with extension **evn**. To discard recorded events, tap the **discard button**. To continue with recording, tap the **resume button**.

Data log

In this sub-menu, the results of the comparison between the current frame and the initial frame are displayed (for every single address). Different colours indicate changes on each address (mismatched data, event) or current device status (dual address, empty address, occupied address). When the data log sub-menu is selected, the application starts recording data logs for each address (flashing red LED (•) in the title bar).

Occupied address	Empty address	Dual address	Mismatched data
			Event flag at this address

Addresses	6	7	8	9	10	11	12	13	14	15	16
Home									OPH		
Addresses				HT							
Analogue value and drift											
Mode and polling LED											
Control and status											
Events				HT							
Data log							HT				

Swipe right from the left side of the screen. The menu selection bar appears.

Tap 'Data Log'. The menu selection bar closes and the Data Log screen appears.

Address — 25 — Soteria AV base presence indication (only in CoreProtocol mode at loop device (1-254))

The meaning of the displayed types:

Type	Description
mismatched data	if data does not match in device type, address confirmation, O/P bit, I/P bits.
event flag at this address	if the event flag is placed during the polling of the device at this address.

Top Bar Menu

In this top bar function for sounder, synchronisation is not used. It also differs from other top bars in the presentation of the loop review.

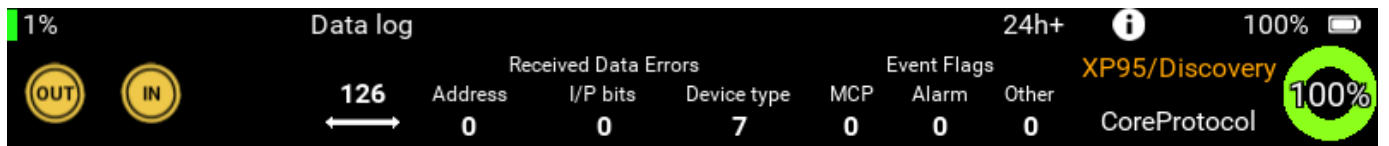

Top bar loop review

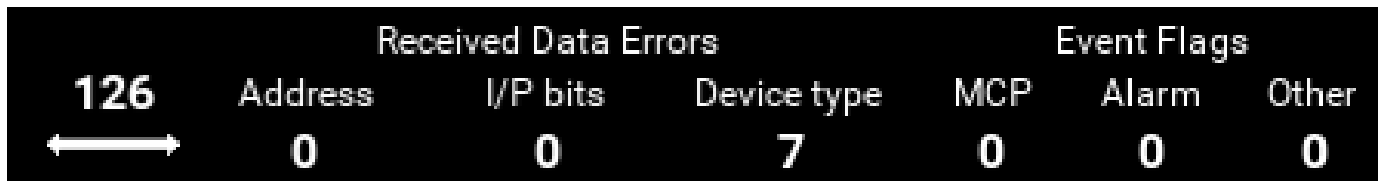

first number – absolute polling range,

all other numbers – sum of the all received data errors and event flags at all addresses in the selected polling range

List of the single address data logs

To display single address data logs, tap the desired address field. To leave the single address data logs view, tap the *back arrow* icon.

1%		Data log					OUT	IN	XP95/Discovery	24h+	100%				
1	2	3	4	5	6	7	8	9	10	11	12	13	14	15	16
17	18	19	20	21	22	23	24	25	26	27	28	29	30	31	32
33	34	35	36	37	38	39	40	41	42	43	44	45	46	47	48
49	50	51	52	53	54	55	56	57	58	59	60	61	62	63	64
65	66	67	68	69	70	71	72	73	74	75	76	77	78	79	80
81	82	83	84	85	86	87	88	89	90	91	92	93	94	95	96
97	98	99	100	101	102	103	104	105	106	107	108	109	110	111	112
113	114	115	116	117	118	119	120	121	122	123	124	125	126		

At the top of the window is a counter of data errors and event flags for the address shown. In the rows, the result of comparison between the current frame and the initial frame is shown.

Time	Address	Device type	Addr. conf.	O/P bits	I/P bits	Analogue value	Drift flag	Events	Parity	Pwr-Up flag
13:20:12	9	SND	✓			16 / 23 / 16				
13:20:03	9	SND	✓			16 / 23 / 16				
13:19:54	9	SND	✓			16 / 23 / 16				
13:19:46	9	SND	✓			16 / 23 / 16				
13:19:37	9	SND	✓			16 / 23 / 16				
13:19:28	9	SND	✓			16 / 23 / 16				
13:19:19	9	SND	✓			16 / 23 / 16				
13:19:10	9	SND	✓			16 / 23 / 16				
13:19:01	9	SND	✓			16 / 23 / 16				
13:18:52	9	SND	✓			16 / 23 / 16				
13:18:44	9	SND	✓			16 / 23 / 16				
13:18:35	9	SND	✓			16 / 23 / 16				
13:18:26	9	SND	✓			16 / 23 / 16				
13:18:17	9	OP	✓			23 / 23 / 23				✓
13:18:08	9	OP	✓			23 / 23 / 23				✓
13:17:59	9	OP	✓			23 / 23 / 23				✓
13:17:51	9	OP	✓			23 / 23 / 23				✓
13:17:42	9	OP	✓			23 / 23 / 23				✓
13:17:33	9	OP	✓			23 / 23 / 23				✓
13:17:24	9	OP	✓			23 / 23 / 23				✓
13:17:15	9	OP	✓			23 / 23 / 23				✓
13:17:06	9	OP	✓			23 / 23 / 23				✓
13:16:57	9	OP	✓			23 / 23 / 23				✓

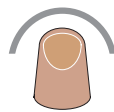

Tap on the address that you want to see the data log. The data log splash screen appears,

Parameter	Description
Address	polled device
Device type	encoded (device type test set ID) and match (✓) /mismatched (X) if current device type does not match initial one, counter value will increase
Address confirmation	match (✓)/mismatched (X) - if current address confirmation does not match initial one, counter value will increase
O/P bits	current status - abbreviations for output bit names - if they are set
I/P bits	match (✓)/mismatched (X) - if current I/P bit status does not match initial one, counter value will increase
Analogue value	min/max/last
Drift flag	match (✓)/mismatched (X)
Events flag	event flags and event address (e.g. I,1 - device at the address 1 placed interrupt bit) - if any event flag is set, counter value will increase
Parity	correct (✓)/incorrect (X)
Power-up flag	match (✓)/mismatched (X) - Soteria devices only, blank for all other devices
Checksum	correct (✓)/incorrect (X) - Soteria devices only, blank for all other devices

Scrolling among logs at the same address

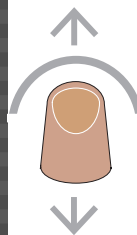

To scroll among logs, swipe up/down (vertical) on the screen.

Scrolling among addresses

Time	Address	Device type	Addr. conf.	O/P bits	I/P bits	Analogue value	Drift flag	Events	Parity	Pwr.Up flag	Chk.
13:20:12	9	SND	✓	✓	✓	16 / 23 / 16					
13:20:03	9	SND	✓	✓	✓	16 / 23 / 16					
13:19:54	9	SND	✓	✓	✓	16 / 23 / 16					
13:19:46	9	SND	✓	✓	✓	16 / 23 / 16					
13:19:37	9	SND	✓	✓	✓	16 / 23 / 16					
13:19:28	9	SND	✓	✓	✓	16 / 23 / 16					
13:19:19	9	SND	✓	✓	✓	16 / 23 / 16					
13:19:10	9	SND	✓	✓	✓	16 / 23 / 16					
13:19:01	9	SND	✓	✓	✓	16 / 23 / 16					
13:18:52	9	SND	✓	✓	✓	16 / 23 / 16					
13:18:44	9	SND	✓	✓	✓	16 / 23 / 16					
13:18:35	9	SND	✓	✓	✓	16 / 23 / 16					
13:18:26	9	SND	✓	✓	✓	16 / 23 / 16					
13:18:17	9	OP	✓	✓	✓	23 / 23 / 23					
13:18:08	9	OP	✓	✓	✓	23 / 23 / 23					
13:17:59	9	OP	✓	✓	✓	23 / 23 / 23					
13:17:51	9	OP	✓	✓	✓	23 / 23 / 23					
13:17:42	9	OP	✓	✓	✓	23 / 23 / 23					
13:17:33	9	OP	✓	✓	✓	23 / 23 / 23					
13:17:24	9	OP	✓	✓	✓	23 / 23 / 23					
13:17:15	9	OP	✓	✓	✓	23 / 23 / 23					
13:17:06	9	OP	✓	✓	✓	23 / 23 / 23					
13:16:57	9	OP	✓	✓	✓	23 / 23 / 23					

To display data logs of another address, swipe left/right (horizontal) on the screen.

Saving Data Logs

To save recorded data logs:

1	2	3	4	5	6	7	8	9	10	11	12	13	14	15	16
17	18	19	20	21	22	23	24	25	26	27	28	29	30	31	32
33	34	35	36	37	38	39	40	41	42	43	44	45	46	47	48
49	50	51	52	53	54	55	56	57	58	59	60	61	62	63	64
65	66	67	68	69	70	71	72	73	74	75	76	77	78	79	80
81	82	83	84	85	86	87	88	89	90	91	92	93	94	95	96
97	98	99	100	101	102	103	104	105	106	107	108	109	110	111	112

Swipe right from the left edge

Home	6	7	8	9	10	11	12	13	14	15
22	23	24	25	26	27	28	29	30	31	
38	39	40	41	42	43	44	45	46	47	
54	55	56	57	58	59	60	61	62	63	
70	71	72	73	74	75	76	77	78	79	
86	87	88	89	90	91	92	93	94	95	
Events	102	103	104	105	106	107	108	109	110	111
Data log	118	119	120	121	122	123	124	125	126	

Tap one of the available options (sub-menus).

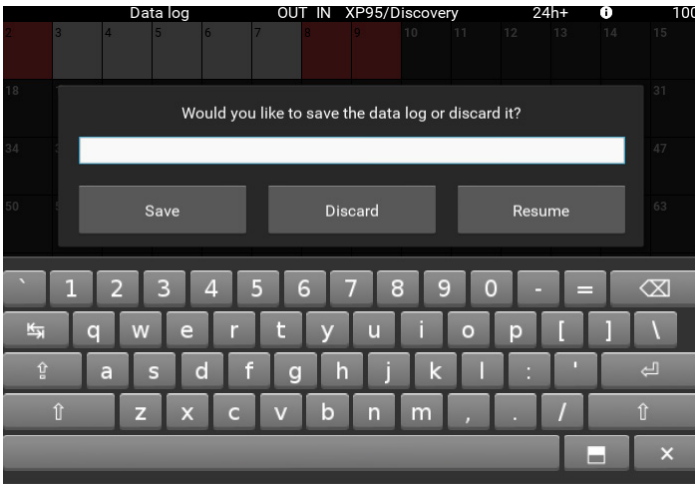

Enter the file name in the opened dialogue box.

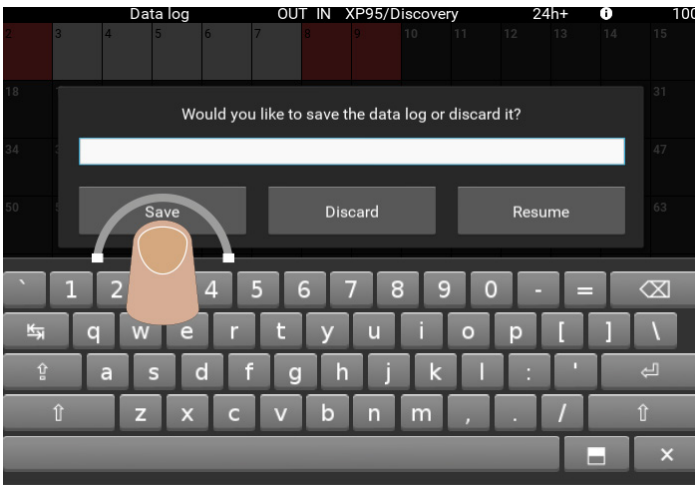

Confirm saving by tapping the 'Save' button.

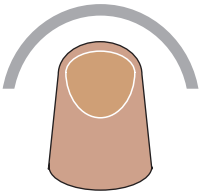

The file is saved with extension **log**. To discard recorded data logs, tap on the **"Discard"** button. To continue with recording, tap on the **"Resume"** button.

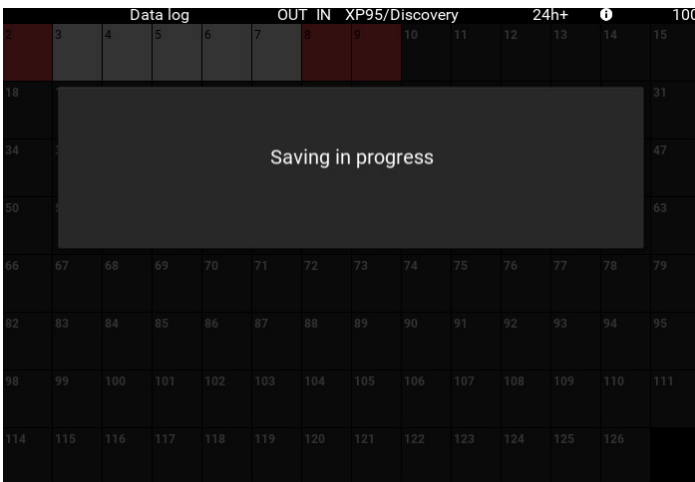

How do I use Programmer mode?

Programmer mode is used with the detector base provided. In this mode only CoreProtocol is used. The detector mounting base with an XPERT8 address card with a pre-defined address of 1.

The detector mounting base will accept all detector types - XP95, Discovery and Soteria. The detector base is connected to the test set unit using the supplied cables into the appropriate connections on the top of the unit.

The Test Set can also be used with manual call points, switch monitors, input/output devices and sounders.

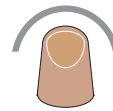

Insert the required device into the detector base.
Tap the 'Programmer mode' tab on the Home screen.
The programmer mode splash screen appears.

Note: If no device is detected 'Device not fitted' appears on the splash screen.

The Programmer mode splash screen shows this information:

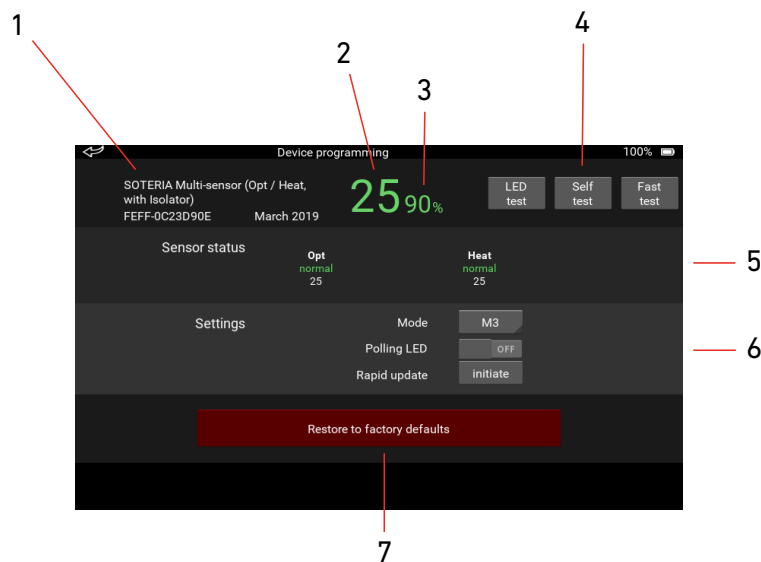

- 1 Currently fitted device information
 1. Device type description
 2. Serial number in hex XXXX-XXXXXXXX (MSB to LSB)*
 3. Date of manufacture - month name, year)**
- 2 Live analogue value
- 3 Drift in % - if device is enabled for this
- 4 Test buttons - only enabled if device will allow these tests.
 - Grey button - deactivated
 - Blue button - activated
- 5 Sensor status*
- 6 Settings ** - available options depend on device type code
- 7 Restore to factory defaults button**

*Note: * Soteria devices only, ** Soteria and Discovery devices only*

Using the Programmer mode test buttons

Self test

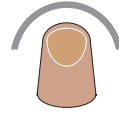
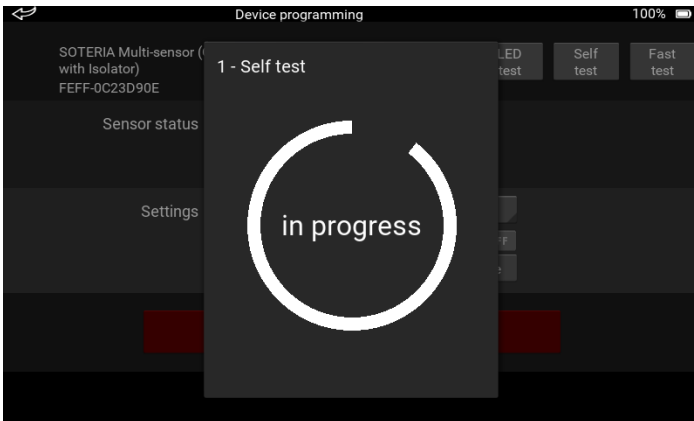

Tap the Self Test button, the self test is activated immediately. The circle represents a countdown timer which is set at 20 seconds. If the analogue value increases to 55 before the timer expires, a 'Pass' splash screen appears, otherwise a 'Fail' splash screen appears.

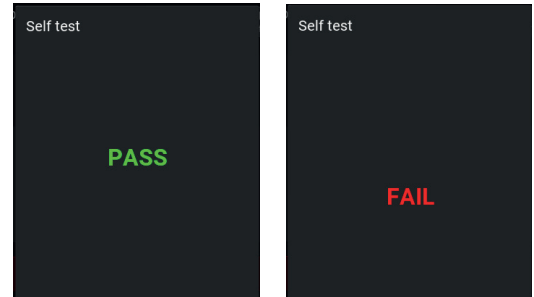

If you want to stop the self test, or close the splash screen after the test, just tap on the main screen, to the left of it.

Fast Test

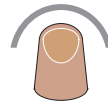
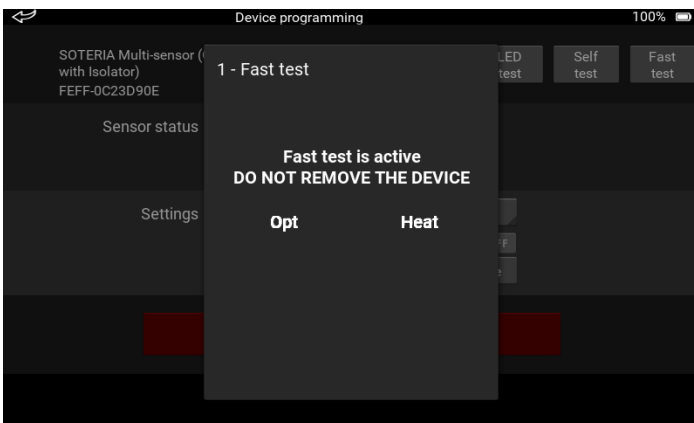

Tap the Fast Test button, the fast test is activated immediately. If a fast test cannot be done - a message 'Fast test cannot be performed' appears and the splash screen returns to the single address view. If the message shown on the left appears, the fast test is active and you should apply smoke or heat to the detector as appropriate.

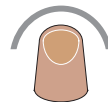
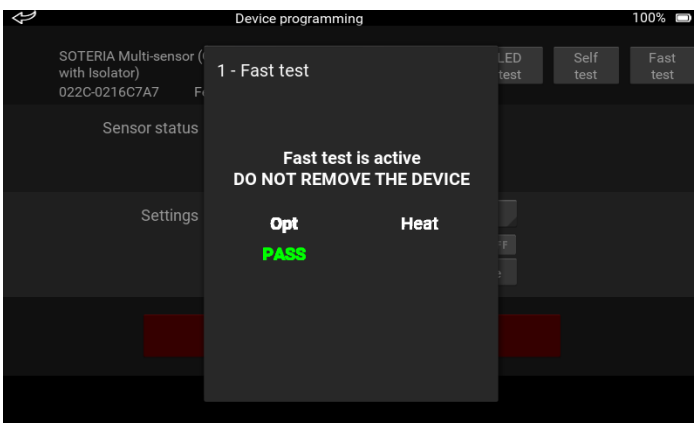

When the sensor in the detector has entered alarm, the green 'Pass' text will appear and the sensor name changes to green. The sensor name remains green until the analogue value returns to its initial value the sensor name then changes to white.

To stop the test or close the Fast Test splash screen, tap on the main screen to the left of it. The data restore operation starts.

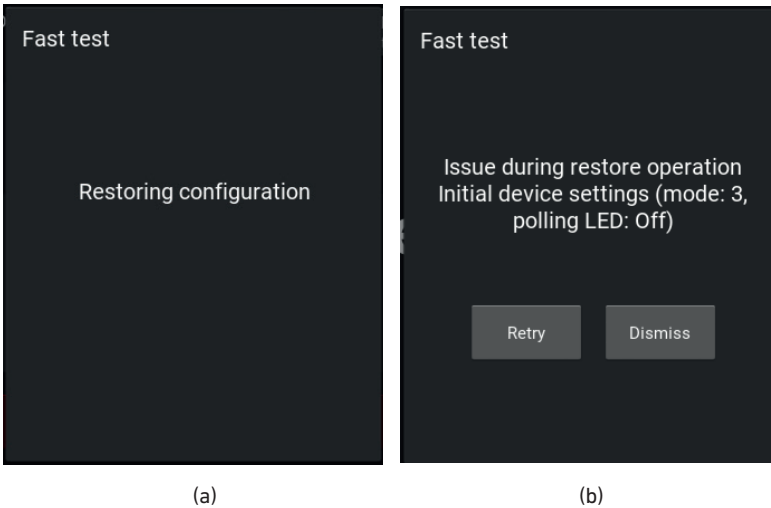

If the device successfully passes the data restore operation, the 'Data restored' splash screen (a) appears. If the data restore is not successful the 'Issue during restore operation' splash screen appears along with details of the initial device settings (mode, polling LED status). Tap either 'Retry' or 'Dismiss' as appropriate.

'Retry' will start the test again.
'Dismiss' closes the Fast Test splash screen.

LED Test

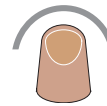
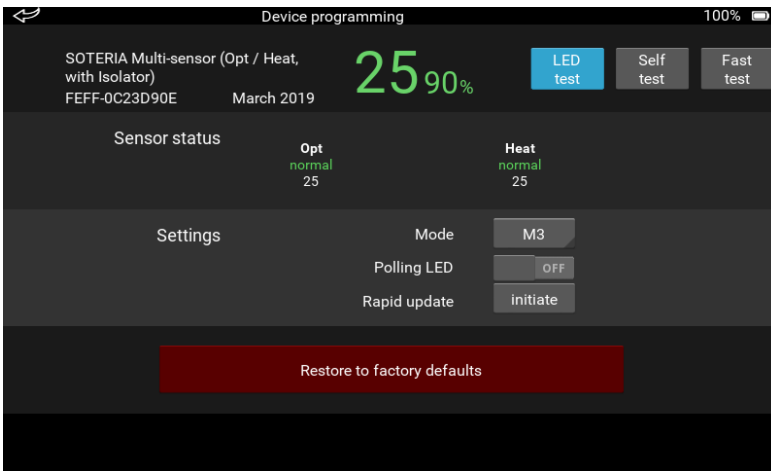

To start the LED test, tap the LED test button. The button colour changes from grey to blue and the LED test is active.

Sensor status

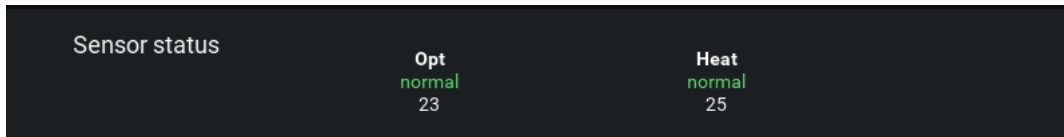

The Sensor status section of the programmer mode splash screen is divided into three rows:

- The top row shows the sensor type
- The middle row shows the last sensor status - the colour of the text indicates its current state:
 - Blue - Fault
 - Green - normal
 - Orange - active
 - Red - alarm
- The bottom row shows the raw sensor value - live temperature for a heat sensor, live optical sensor value or live CO sensor value.

Settings

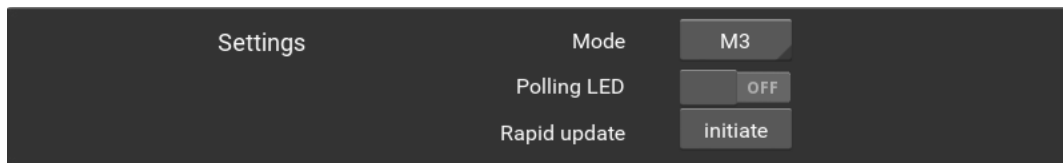

The Settings section of the programmer mode splash screen enables you to adjust the settings of a Discovery or Soteria device. The available options depend upon the type of device that is fitted to the mounting base.

Mode

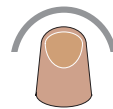
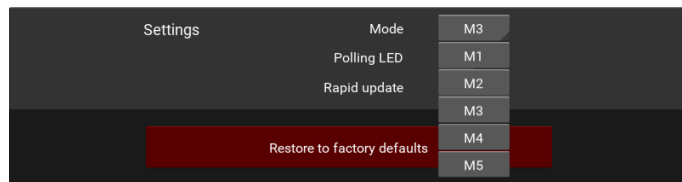

To change the device mode, tap the mode button. A drop-down list appears showing the available modes.

Tap the mode you require. The drop-down list closes and the selected mode is shown.

Polling LED

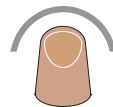

To change the polling status, tap the Polling LED button. The polling status is changed and the active status is highlighted blue.

Rapid update

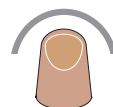
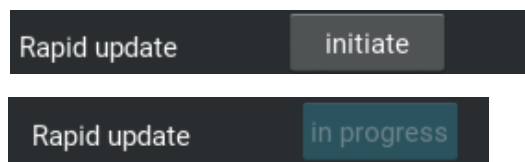

To start rapid update of the device, tap the 'initiate' button. The words 'in progress' appear, the colour changes from grey to blue and 'darkens' this means that its state cannot be changed during the update period - 30 seconds. When the update is finished the button colour returns to grey.

Restore to factory defaults

This button restores a Discovery or Soteria device to its factory defaults. Remember that if you use this option, all non-volatile memory including the soft address will be reset.

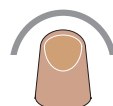
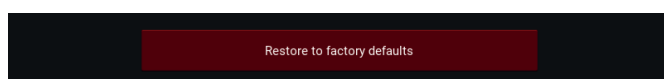

Tap the 'Restore to factory defaults' button. A warning splash screen appears.

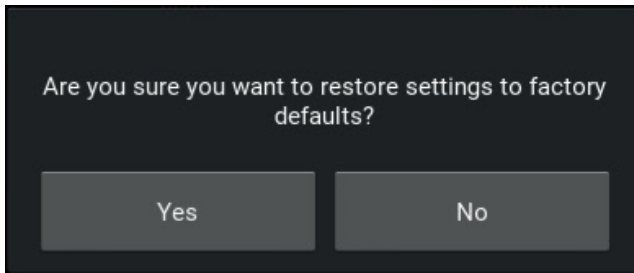

If you want to proceed with the reset, tap 'Yes'. The reset is started. The splash screen closes when it is complete.

If you don't want to reset the device, tap 'No'. The reset is not done and the splash screen closes.

Sounders

Additional fields become available if a sounder is connected to the Test Set in Programmer mode.

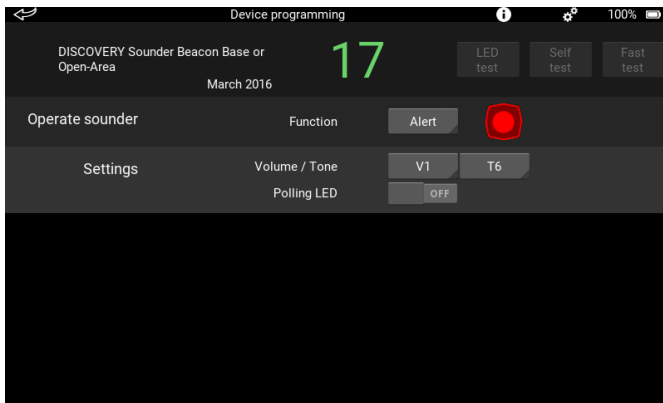

Two sounder functions are available, alert and evacuate.

Tap 'Alert', a drop-down appears that enables you to choose between the alert and evacuate functions.

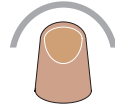

Tap and hold the sounder icon. The sounder will operate until you remove your finger from the icon.

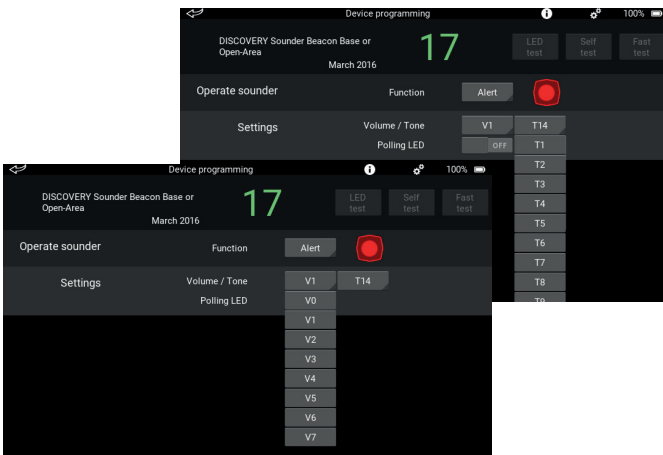
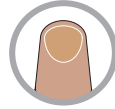

Tap the volume button, a drop-down appears. Tap to select the required volume level.

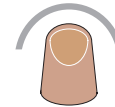

Tap the tone button, a drop-down appears. Tap to select the required tone.

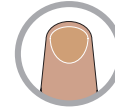

To test the selected tone and volume, tap and hold the sounder icon. The sounder will operate until you remove your finger.

Beacons

Additional fields become available if a beacon is connected to the Test Set in Programmer mode.

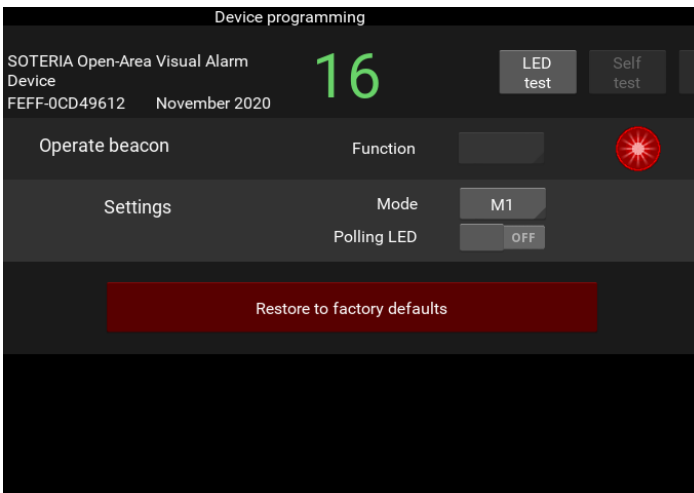

Tap and hold the beacon icon. The beacon will operate until you remove your finger from the icon.

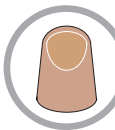

Operate relays

The Operate Relays field is available if an Input/Output Module is fitted to the test set unit. The number of switches available are equal to the number of relays which depends upon the device type.

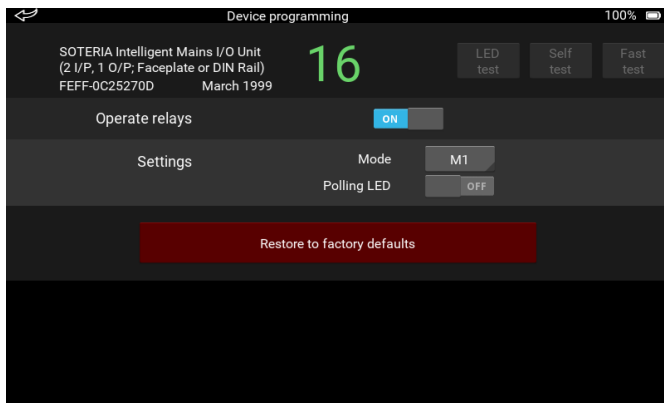

To change the status of a relay, tap the 'Operate relays' button. When the relay is enabled the button colour changes from grey to blue.

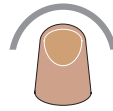

The relay settings are change by tapping the button of the setting to be changed. Tap 'Mode' a drop-down appears. Tap to select the required mode.

Changing the soft address is detailed on page 23.

Soft Addressing Menu

Soteria devices can be set via soft addressing using a programmer.



To set soft address, the XPERT card must be removed from the attached device base. If the device is plugged into a base fitted with an XPERT card, the value of soft address will be overwritten by the hard address.

The Soft addressing mode has a detector mounting base without an XPERT card (it is the mounting base which is used in Programmer mode but without an XPERT card).

Soteria devices which use a DIL switch must be set to **address 255** - this will enable the soft address functionality.

A single tap on the Soft addressing button opens the Soft addressing menu. In the beginning, an informative message appears which warns the user that the XPERT card must be removed from the device base before continuing. Tap on the message to continue.

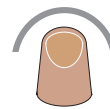

On the Home Screen, tap the 'Soft Addressing' tab. The XPERT card warning message will then appear.

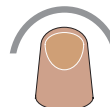
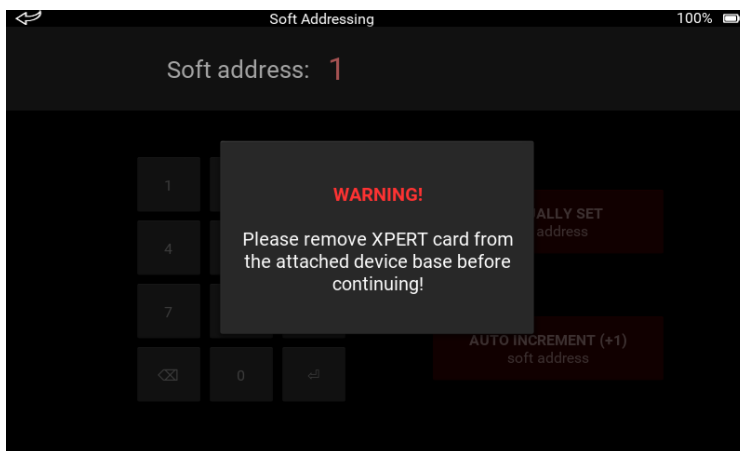

Tap on the message to continue.

The Soft Addressing screen will then appear.

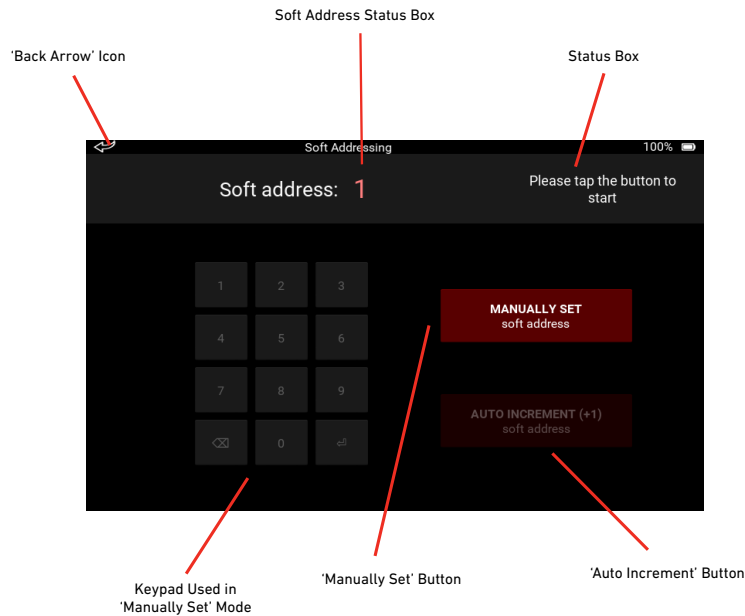

'Back Arrow' Icon

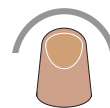
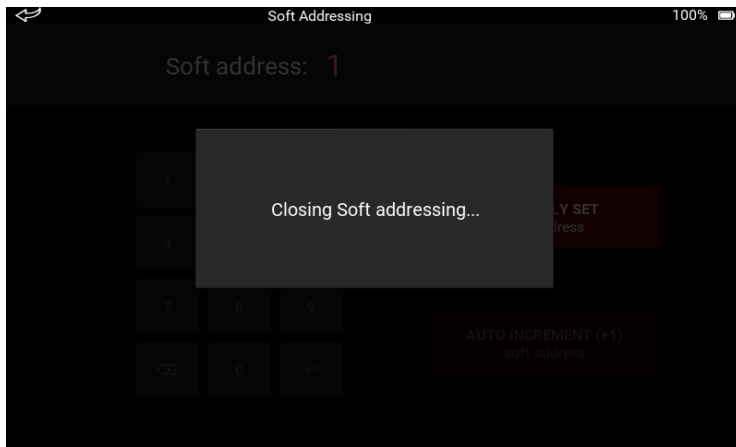

A single tap on the 'Back Arrow' icon is needed to close the Soft addressing mode (pop-up message appears – 'Closing Soft addressing ...').

During device initialization and address set/lock process icon is disabled, otherwise is enabled.

Soft Address Status Box

Two different colours are used to indicate soft address status in the current session.

Colour	Address Status (*current session)
red	unlocked
green	locked

**current session - current session is the interval of one set of soft address' (it can be terminated / finished when the user removes the device from the device base. Select button for new soft addressing or leave the menu)*

Status Box

Status Box informs the user on the progress of soft addressing and guides them through the procedure.

Keypad

The keypad is used to enter a soft address (only in 'Manually Set' mode).

'Manually Set Soft Address' Button

This option enables the user to manually set a soft address. The smart keypad is used - user can enter only valid values (1-254). In the first session, only this option is available (the auto increment is disabled).

'Auto Increment (+1) Soft Address' Button

This option automatically increments the current soft address by 1 (example: current soft address = 4, user taps button, new soft address is set to = 5 (current soft address + 1)). The whole procedure runs automatically and a user does not need any additional interaction with the user interface.

Manually Set Soft Address

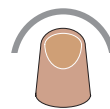
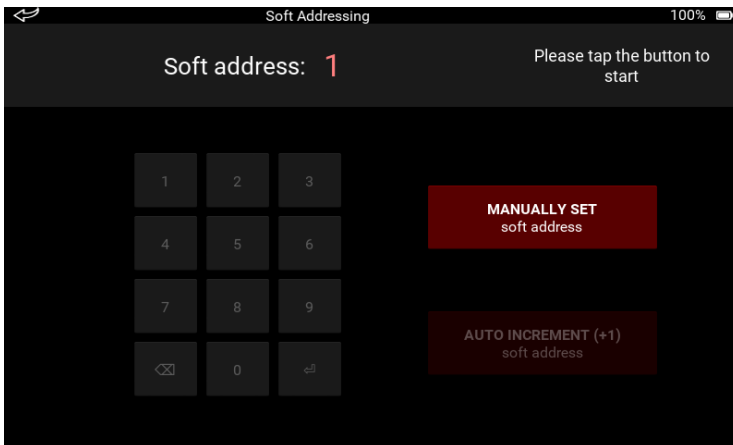

In the first session, only this option is enabled. The predefined soft address is set to 1. In the status box are instructions for the user. The manually set soft address button is not locked and should be pressed to being initialization.

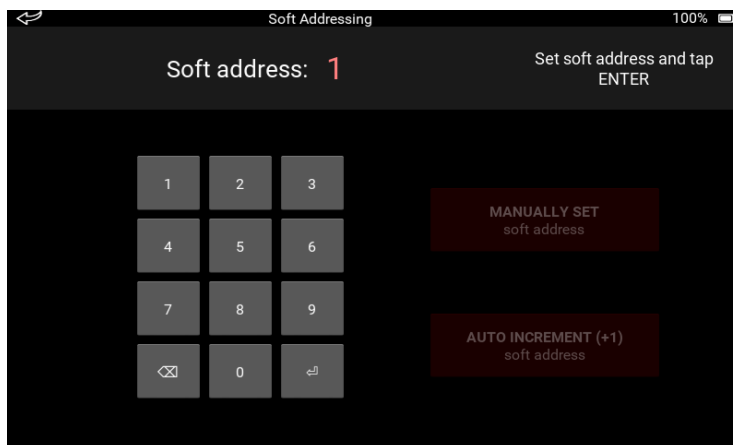

Tapping on the button starts the device initialization process (it can take up to 5 s).

In the status box, the user can monitor the progress. If the initialization is successful, then the keypad becomes enabled and the user can enter the soft address (instructions are provided in a status box while the currently selected address is displayed in soft address box).

To complete the address, the user must tap the Enter button.

Manually Set Soft Address - (Failed Initialization)

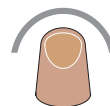
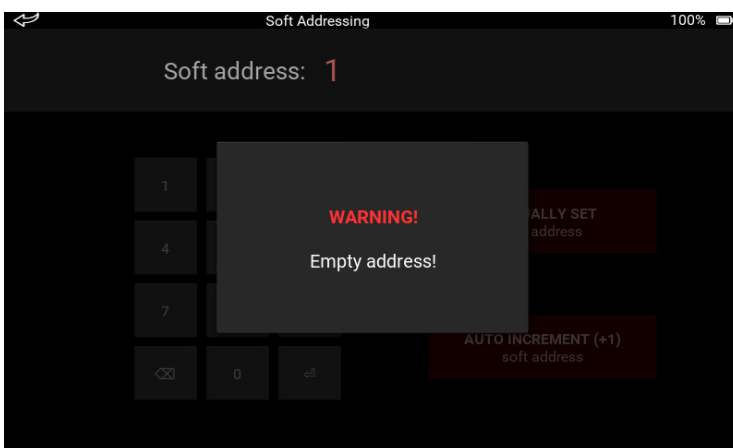

If something goes wrong during the device initialization, a pop-up message will appear on the screen (it lasts for 4 s - if the user does not tap the message before). A possible reason for the failure can be (text is displayed in message):

- Empty address,
- Dual address,
- Corrupted data or
- Invalid data.

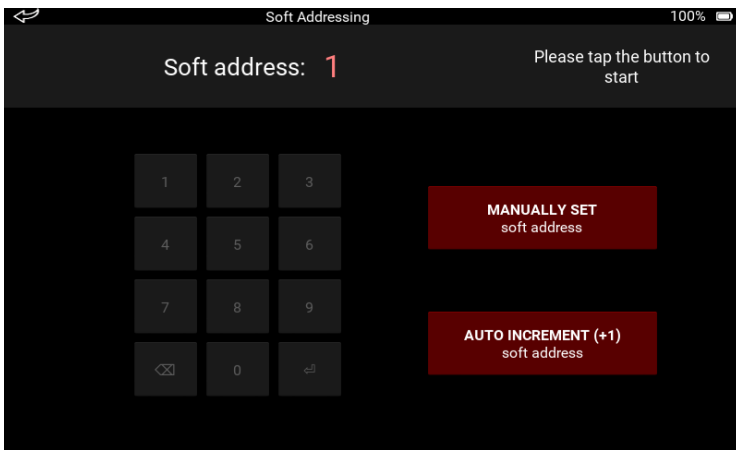

After, the user interface goes back to its initial state (both buttons enabled, keypad disabled).

Manually Set Soft Address - (Successful Initialization)

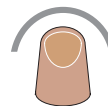
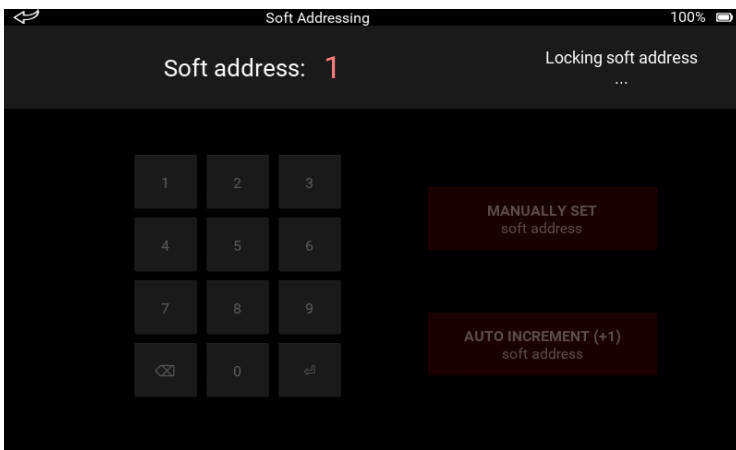

When the user taps Enter, the keypad becomes disabled. The application starts the locking procedure. Status is displayed in the status box.

Manually Set Soft Address - (Failed Locking)

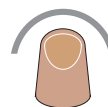
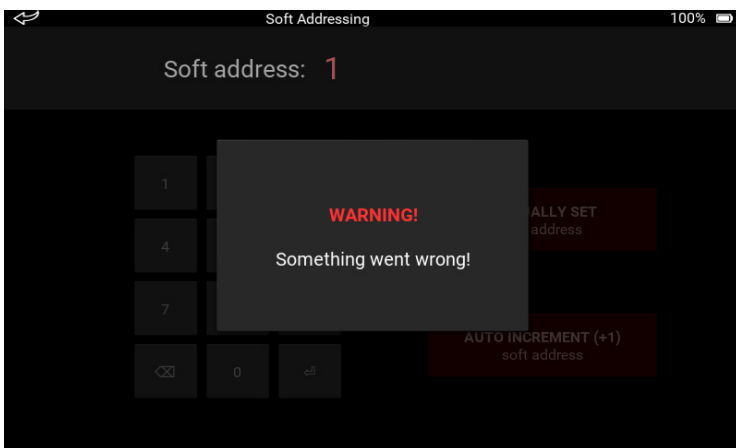

If something goes wrong during locking procedure, a pop-up message will appear on the screen (it lasts for 4 s - if the user does not tap the message beforehand).

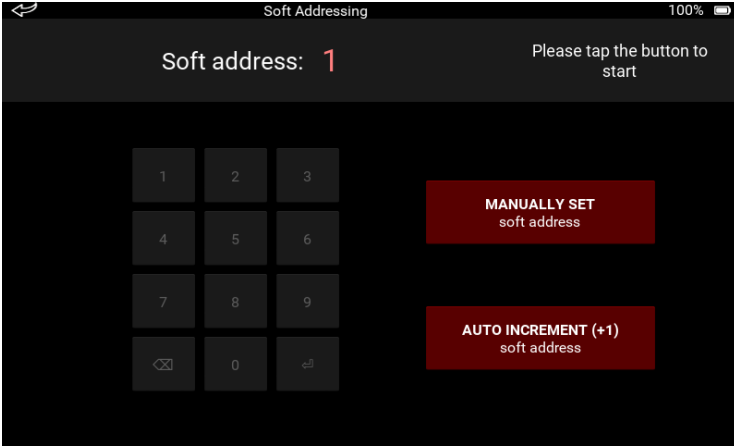

After, the user interface goes back to its initial state (both buttons enabled, keypad disabled).

Manually Set Soft Address - (Successful Locking)

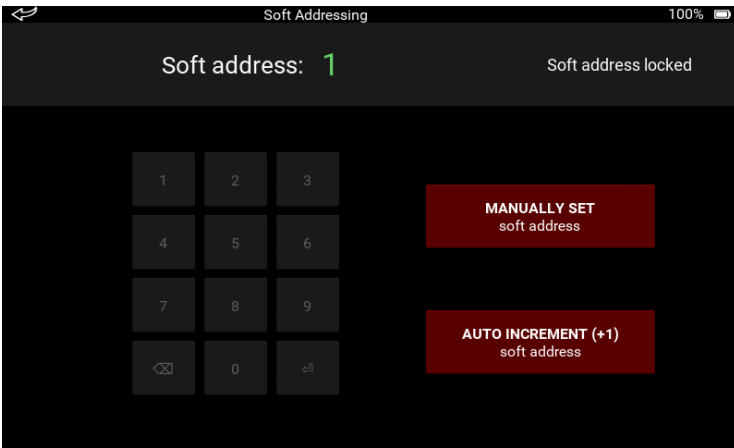

If the locking procedure was carried out successfully, then the number in soft address box becomes green.

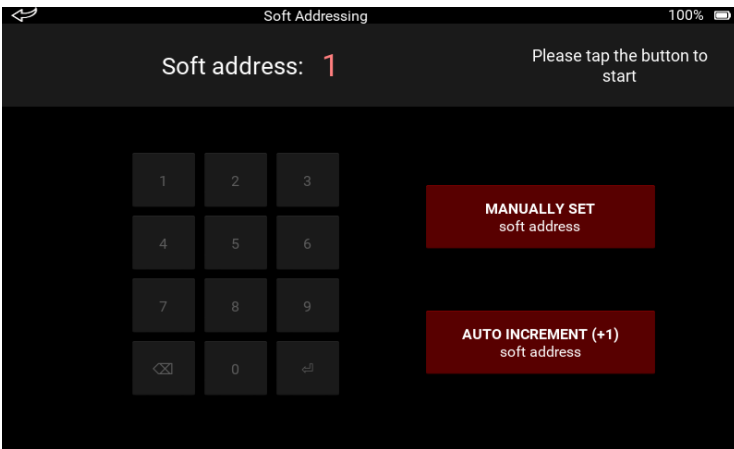

If the user removes the device, the user interface goes back to the initial state.

Auto Increment (+1) Soft Address

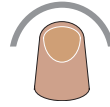
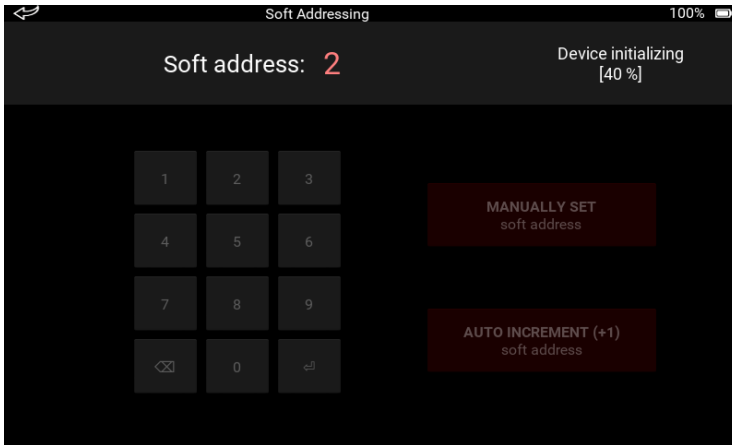

If the user selects the auto increment button then all procedure is performed automatically without any interrupts for the user.

The procedure is the same as in the case of manual set. The only difference is that soft address is already defined and the user does not need to set it (keypad is disabled).

If something goes wrong during initialization or locking process the same messages appear as in case of manually set address.

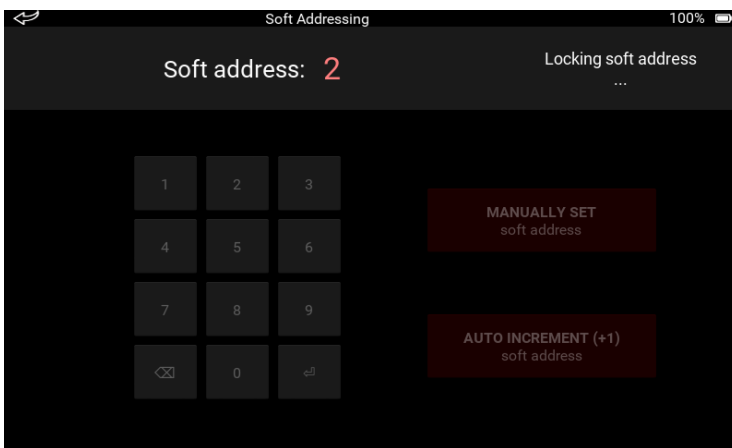

How do I use Loop diagnostics?

Loop diagnostics provide:

- Wire connection test
- Short circuit fault test
- Earth fault test
- Loop voltage and current measurement
- Loop cable impedance measurement
- Automatic detection of earth fault location

These tests and measurements are divided into four groups:

- Short circuit fault/earth fault detection
- Loop supply - from OUT - voltage and current measurement
- Loop supply - from IN - voltage and current measurement
- Earth fault location search

The pages that follow give a brief overview of each of the loop diagnostics procedures. For full details, please refer to Appendices A to E on pages 43 to 47.

Short circuit fault/earth fault detection

This is the core test of loop diagnostics. It shows the results of the wire connection test, short circuit fault test, earth fault test and loop cable impedance measurement.

It is a step-by-step process, which means only the first detected fault is shown; the Test Set then stops any further testing. Testing is not resumed until the appropriate on-screen button is selected.



To start the short circuit fault/earth fault detection test:



On the Home Screen, tap the 'Loop diagnostics' tab. The loop diagnostics screen appears.

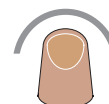
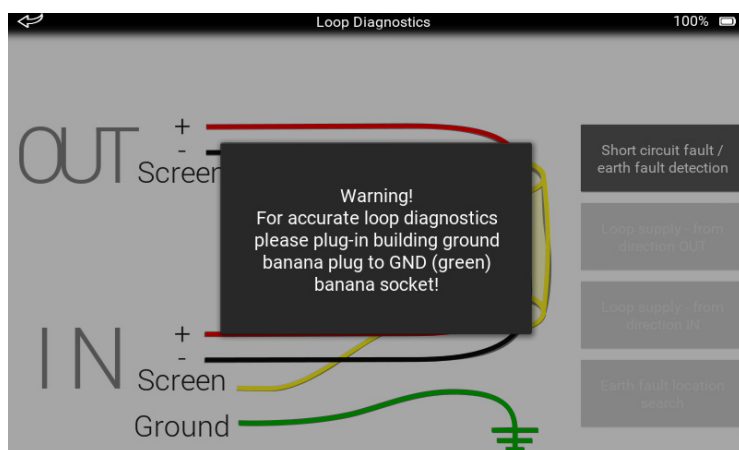

A warning splash screen appears requesting that the building ground banana plug should be plugged into the GND banana socket on the Test Set. After doing this, tap the screen and loop diagnostics will start.

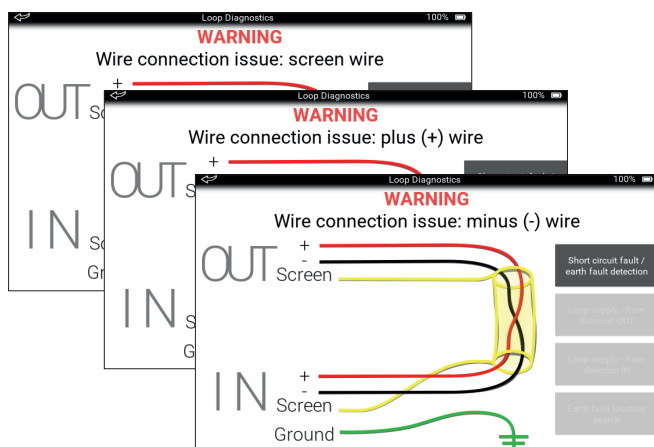

The first thing tested is the loop integrity.

If there is a broken wire or it is not plugged into a socket, a warning message 'Wire connection issue' appears below the top bar.

In addition it will tell you which wire is carrying the fault. The message will continue as appropriate with one of these statements:

- 'screen wire'
- 'plus (+) wire'
- 'minus (-) wire'

The fault should be investigated and corrected before continuing.

The grey box on the right of the schematic shows what test is being done.

Short circuit fault

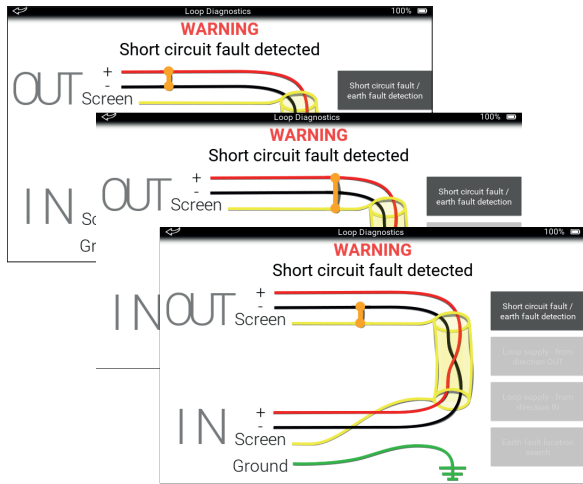

If a short circuit fault is detected between;

- ' + and - '
- ' + and screen '
- ' - and screen '

A warning message '**Short circuit fault detected**' appears below the top bar and a bold orange connection line is shown between the two affected wires.

The fault should be investigated and corrected before continuing.

Earth fault

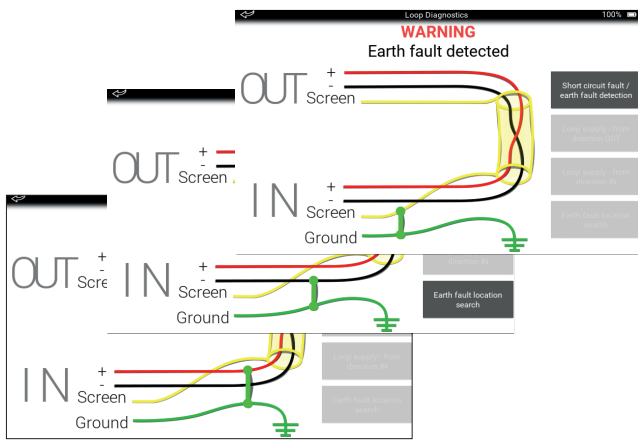

If an earth fault is detected between:

- ' + and GND '
- ' - and GND '
- ' Screen and GND '

A warning message '**Earth fault detected**' appears below the top bar and a bold green connection is shown between the two affected wires.

The fault should be investigated and corrected before proceeding.

Accuracy, resolution and range

	Accuracy	Resolution	Range
Loop Current	-/+ 500 μ A	100 μ A	(0 - 500) mA
Loop Voltage	-/+ 100 mV	100 mV	(0 - 40) V
Cable Impedance (*)	-/+ 10 m	1 m	(10 - 4178) m

(*) indirect measurement (voltage drop)

Cable impedance and cable run

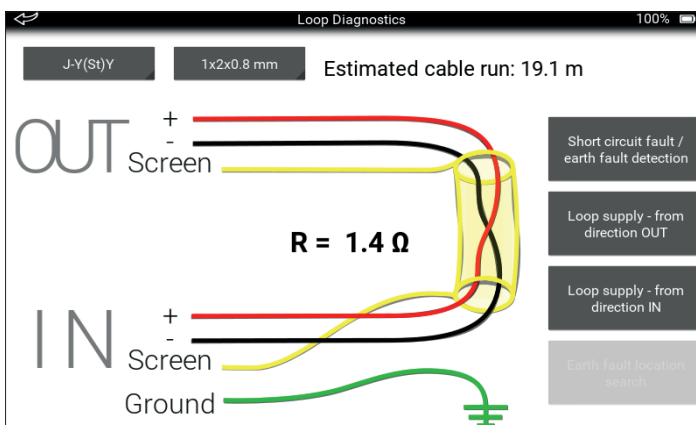

When a cable run is between 10 and 4178 metres, cable impedance and cable run values are shown on the screen.

If cable is not available, warning appears '*Cable not available*'.

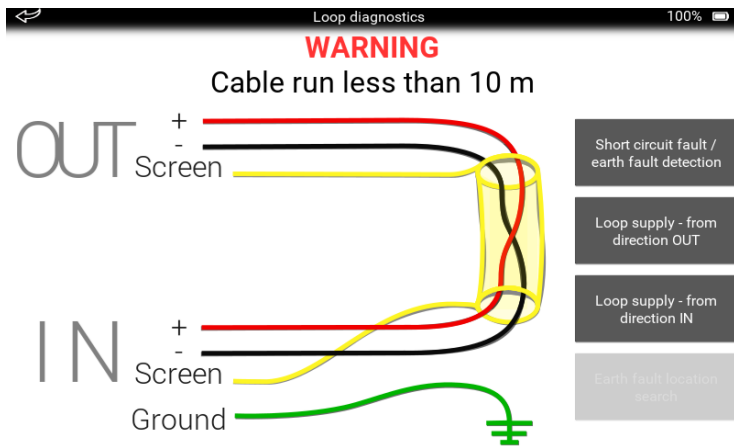

If the cable run is either less than 10 metres in length, or, more than 4178 metres a warning message appears below the top bar.

Loop supply - from direction OUT

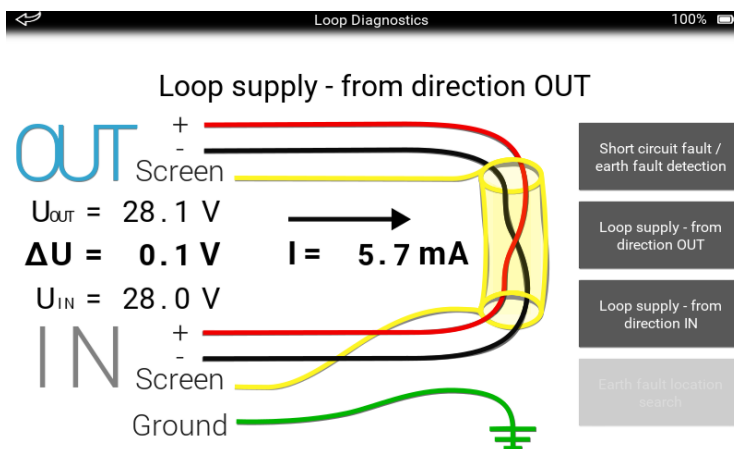
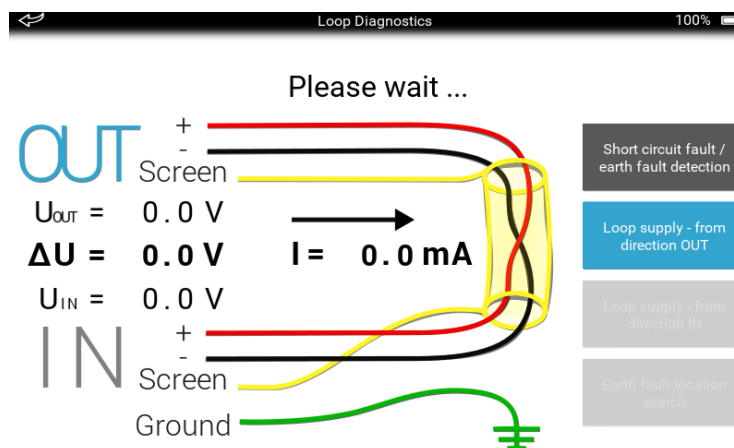

Loop supply measurements are only possible if there are no faults on the loop. The loop is supplied with 28 V dc from OUT, coloured blue on-screen. The voltage is measured on the IN side, with the direction of current flow from OUT to IN. The screen also shows the difference between the OUT and IN voltages.

Loop supply - from direction IN

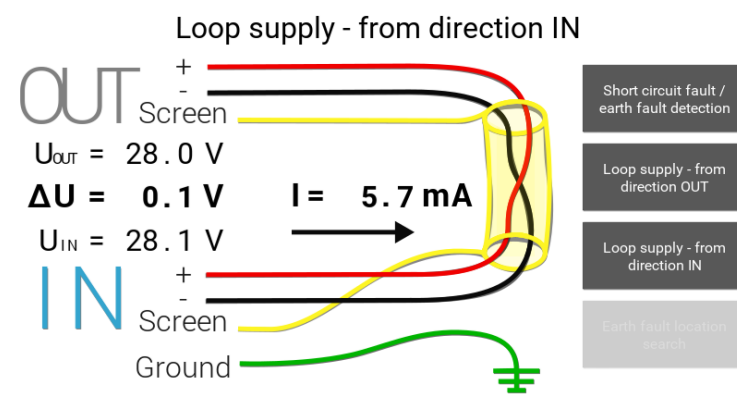
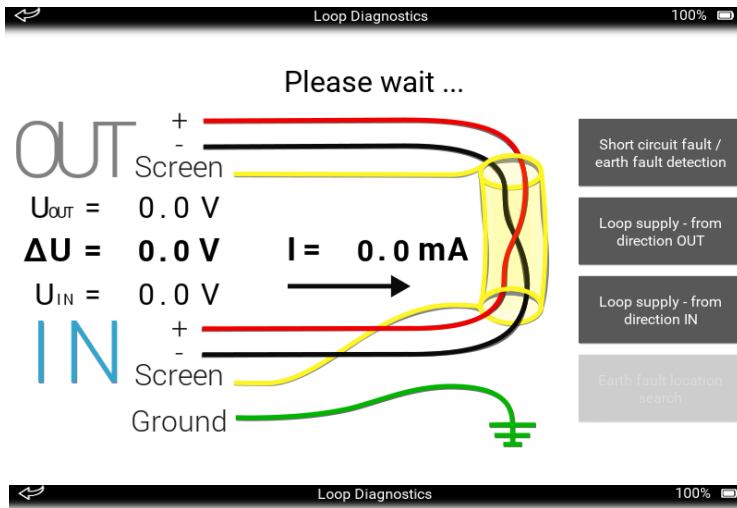

Loop supply measurements are only possible if there are no faults on the loop. The loop is supplied with 28 V dc from IN, coloured blue on-screen. The voltage is measured on the OUT side, with the direction of current flow from IN to OUT. The screen also shows the difference between the OUT and IN voltages

Earth fault location search

The earth fault location search for the automatic detection of the earth fault location on the negative loop conductor can only be done on a Soteria system with isolators. It can also only be done under certain conditions, that is, when all connections are good and there is no short circuit between the loop plus and minus wires.

The earth fault location search is made up of three steps:

1. Occupied addresses search
2. Loop devices map building
3. Earth fault location search

Occupied address search

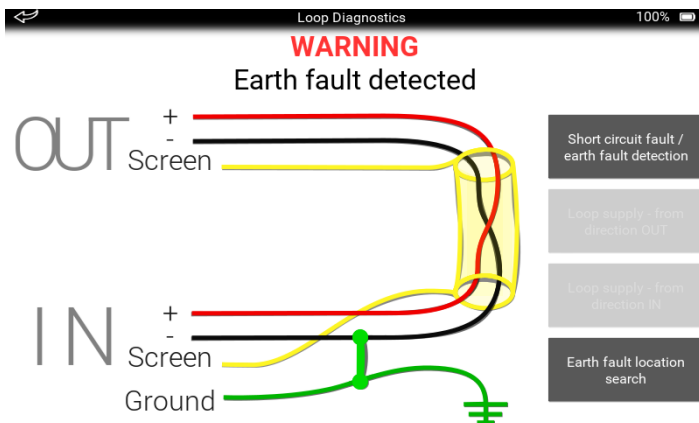

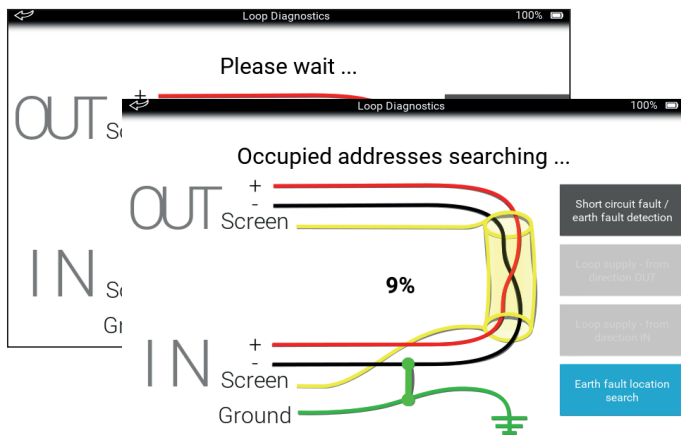

In the occupied address search, the device polls all 254 addresses. The progress is shown as a percentage on screen.

A list of occupied addresses is produced, but if there is an issue such as an empty loop, legacy device, non-isolated device or dual address, the search stops and a warning is shown.

Loop devices map building

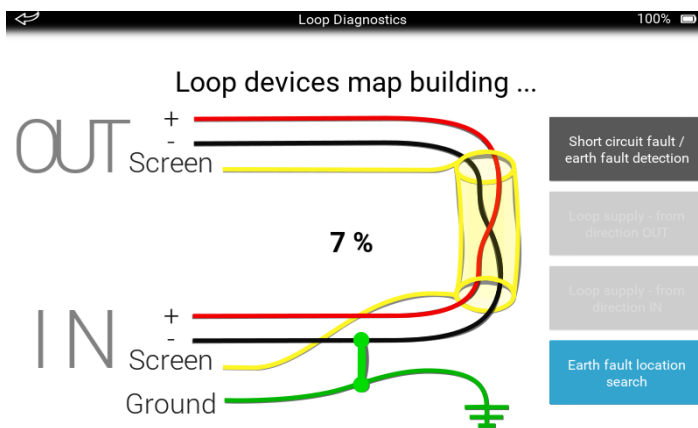

Loop devices map building function uses the Soteria isolator function to break the loop and sort.

It then sorts the addresses into an 'as fitted' order. Progress is indicated as a percentage, but if there is an issue the process stops and a warning is shown.

Earth fault location search

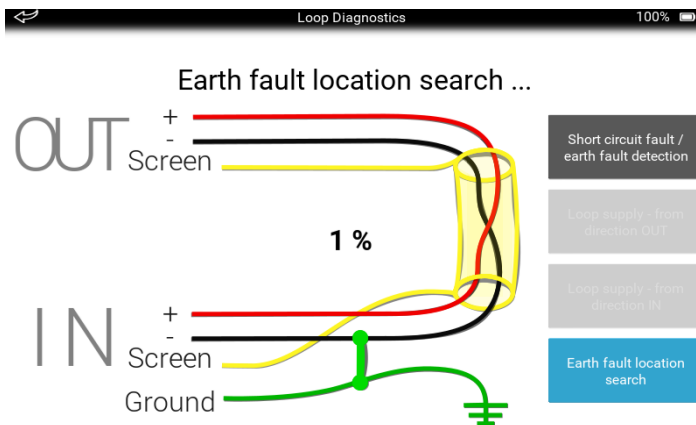

In this process, the Soteria isolator control function and the earth fault test are used to detect and report where a fault is. Progress is shown as a percentage on screen.

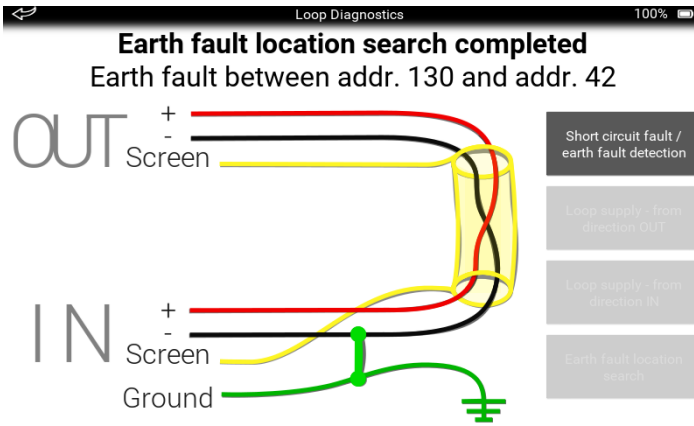

If there is an earth fault detected in a single location. The result is shown as a location between two addresses.

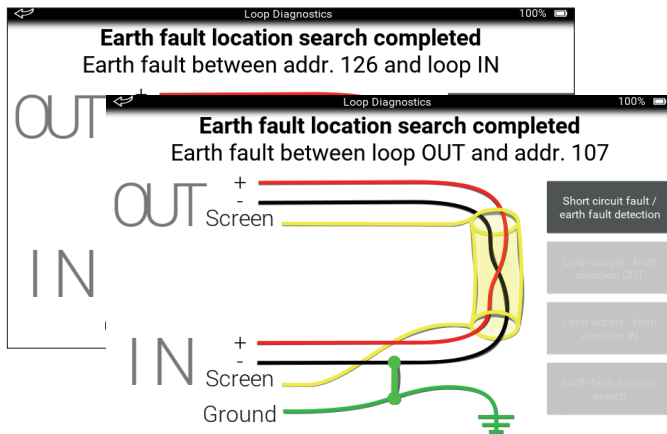

If there is more than one earth fault detected, the result is shown as either between an address and the IN loop, or between an address and the OUT loop. To find the fault you should check the loop back from the address that is given.

How do I enter a location?

The Location function enables you to enter a location where a test has been done.

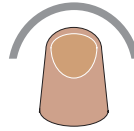

To enter a location, on the home screen tap the 'Location' tab. This is the tab immediately below 'Location' on the home screen. A drop-down appears listing all the locations.

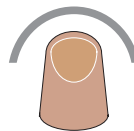
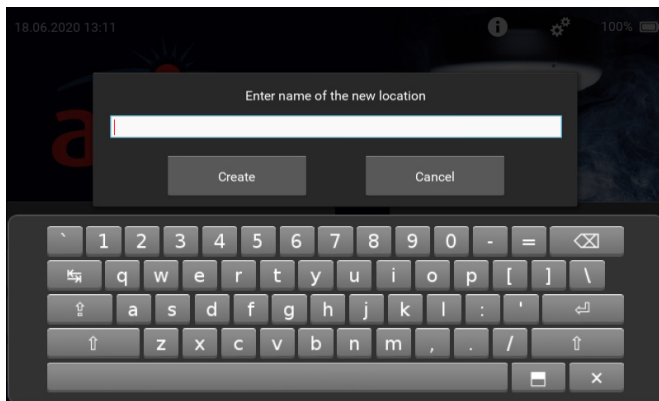

Either tap an existing location, or 'new location', an on-screen keyboard appears.

Type in the name of the new location and tap 'Create'. The on-screen keyboard closes and a tab with the new location appears in the drop-down.

When a location is added, the Stored Events, Data logs tab becomes available for that location.

How do I use Stored Data?

If a location is entered on the Test Set, the Stored Reports, Stored Configurations, Stored Events, and Data Logs tab becomes available.

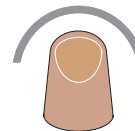

Tap the 'Stored Data' tab. The stored data screen appears.

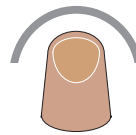
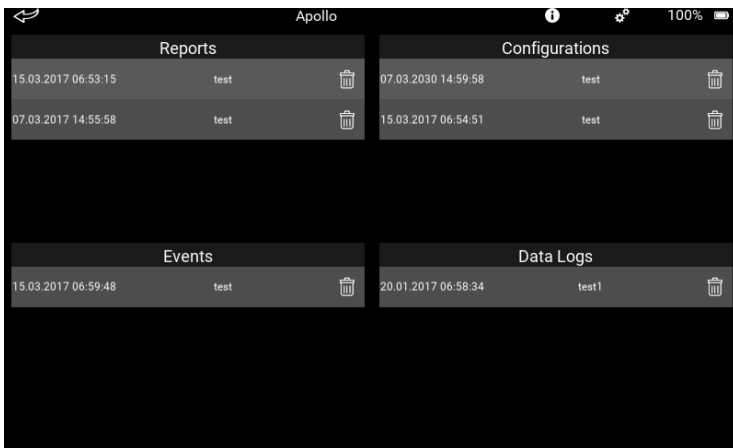

Tap the report that you want to see in detail. The message 'Loading in progress' appears, followed by the report screen.

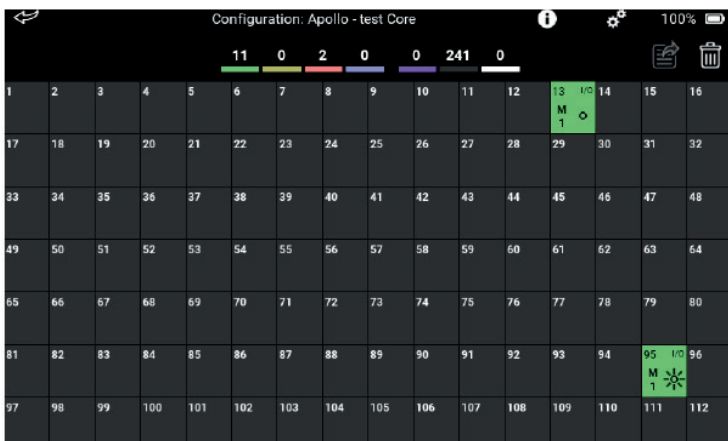

When you have finished with the report, there are now two choices:
 1. The report can be deleted
 2. The report can be exported to a USB flash stick as a .csv file.

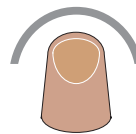
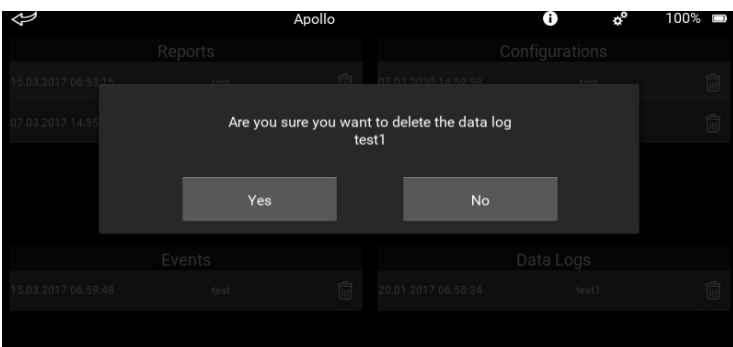

To delete the report:

 Tap the dustbin icon. A splash screen appears asking you to confirm the deletion. Tap 'Yes' to delete the report, tap 'No' to return to the report screen.

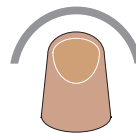
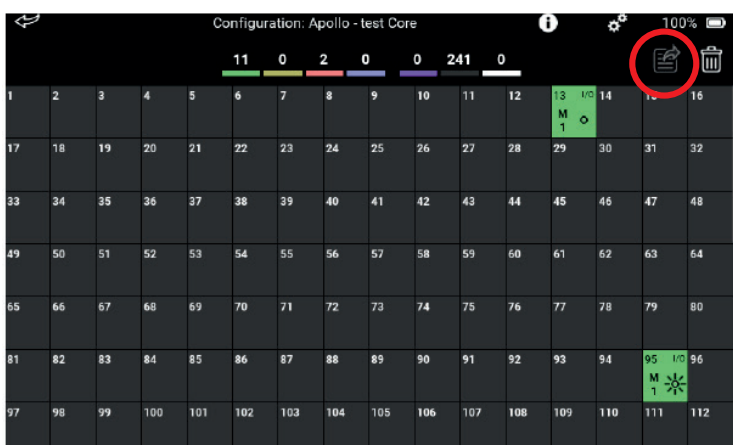

To export the report onto a USB device as a .csv file:
 1. Insert a USB flash stick into the USB slot on the side of the Test Set. The export icon is highlighted.
 2. Tap the highlighted icon. The on-screen keyboard appears.
 3. Enter the file title and tap 'Export'

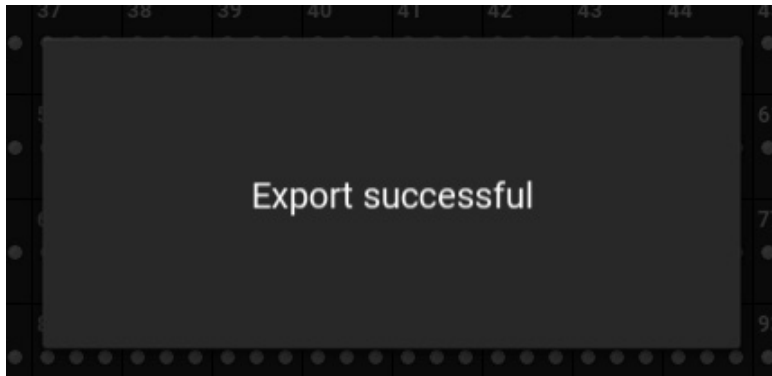

When the file has been exported a splash screen appears showing the export has been a success.

Tap the back arrow to return to the Home page.

How do you open the exported file?

File format is CSV. As delimiter is used semicolon (;). File can be opened with Microsoft Office Excel or any other appropriate tool. To open file in Microsoft Office Excel follow the instructions below.

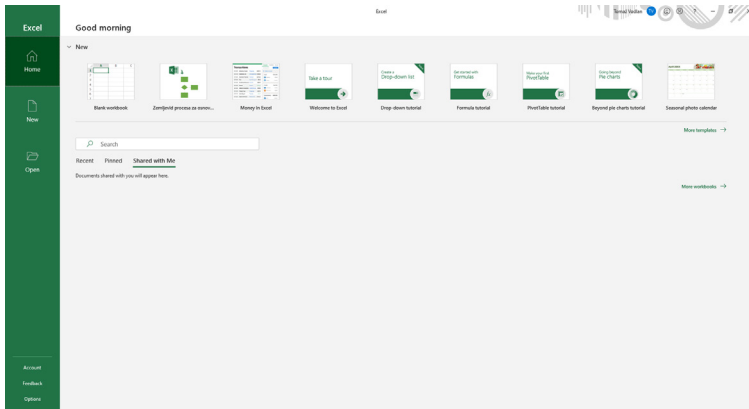

Open Excel and choose **Blank Workbook**.

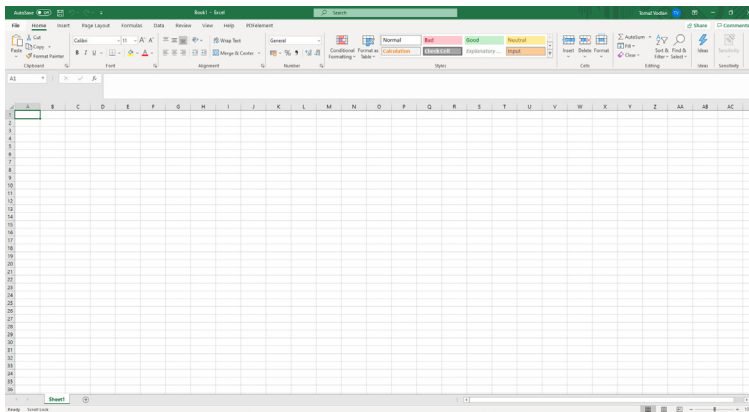

In Menu Bar select **Data** tab.

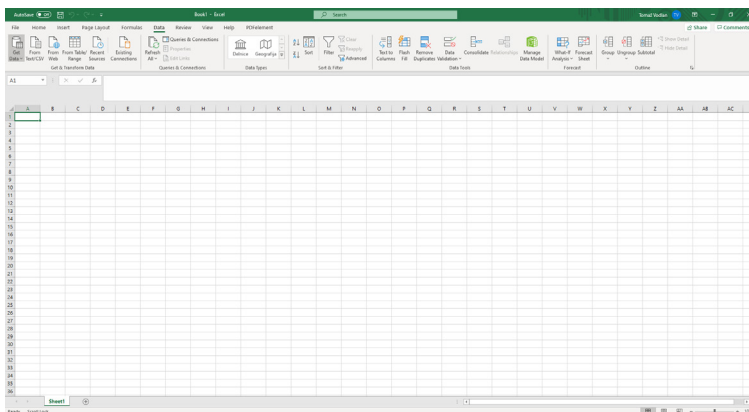

Select option **From Text/CSV** on the Data ribbon.

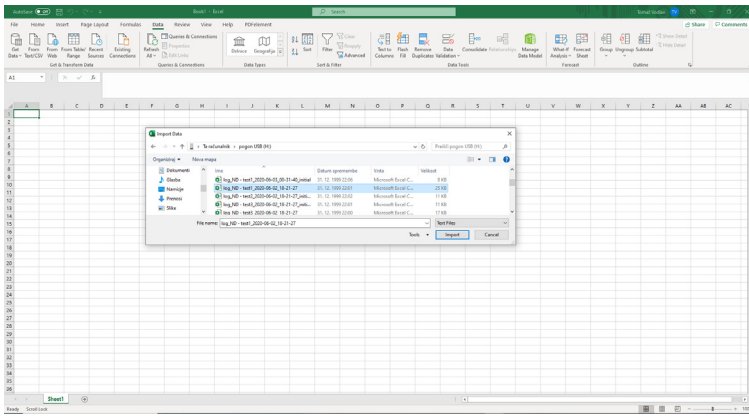

A new window opens. From the list, select file to import and then click the **Import** button.

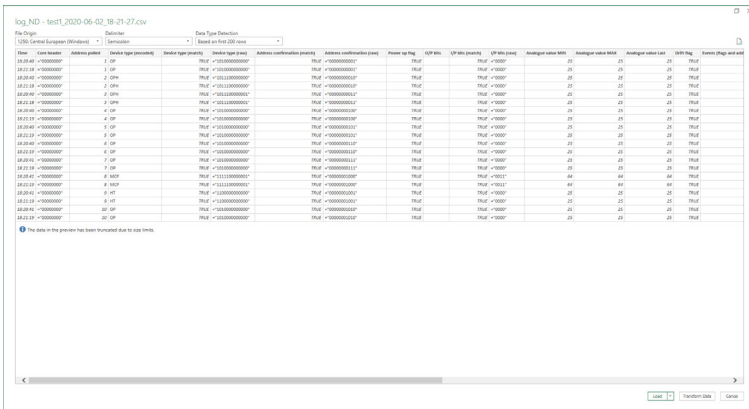

A new window opens - proposal of how data should be separated and shown. Excel automatically detects which delimiter is used, based on the first 200 rows.

Click the **Load** button.

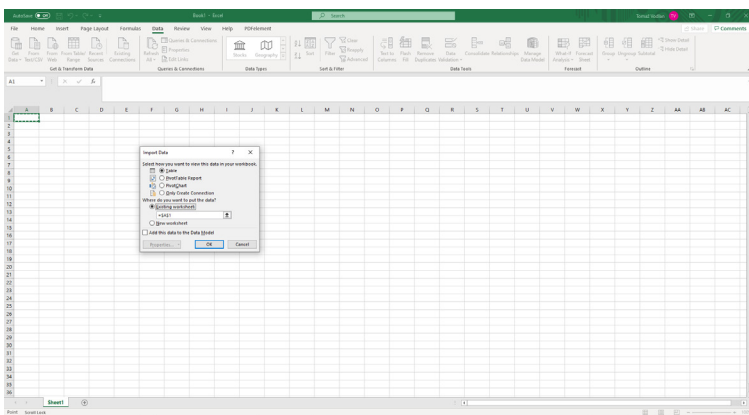

New sub-window appears. Two options are available where data could be imported.

Import in current Sheet -> select options **Existing worksheet** under question *Where do you want to put the data?*

Import in new sheet -> select option **New worksheet** under question *Where do you want to put the data?*

Then click **OK**.

How do I update firmware?

To make sure that the Test Set operates efficiently, it may be necessary to update the firmware that operates it. Firmware updates will be made available on www.apollo-fire.co.uk and will require loading onto a USB flash drive.

To install the firmware update:

1. Connect the power supply cable to the Test Set and a suitable power supply.
2. Plug the USB flash drive containing the firmware update into the USB socket of the Test Set.
3. Make a note of the firmware update version number.

The full Firmware Update flowchart can be found on page 48.

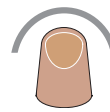
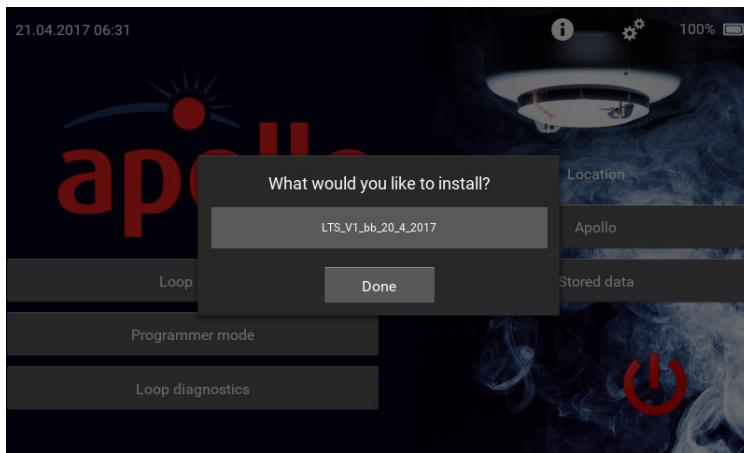

The firmware update screen appears. Tap the update to be installed.

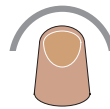
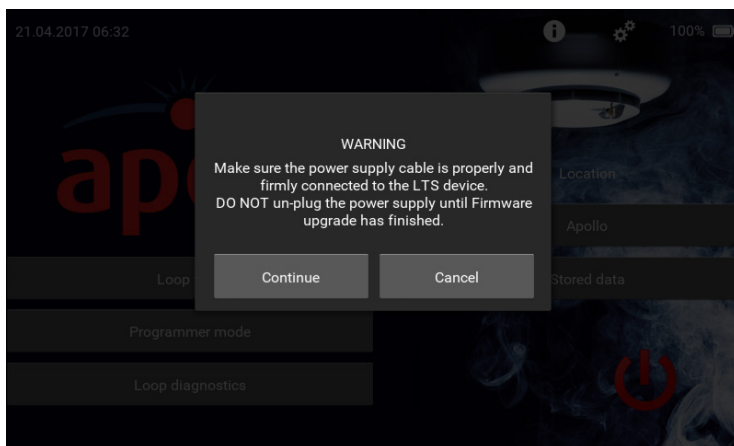

The Warning splash screen appears. Check that the power supply cable is correctly attached to the Test Set and tap 'Continue'.

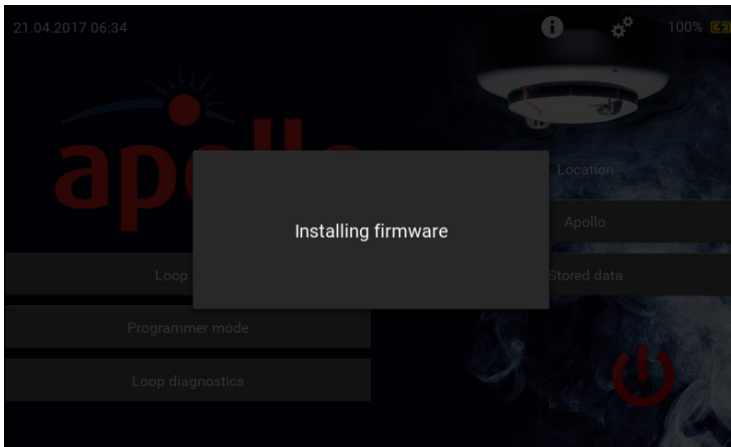

The 'Installing firmware' screen appears. DO NOT do anything with the Test Set during the update process.

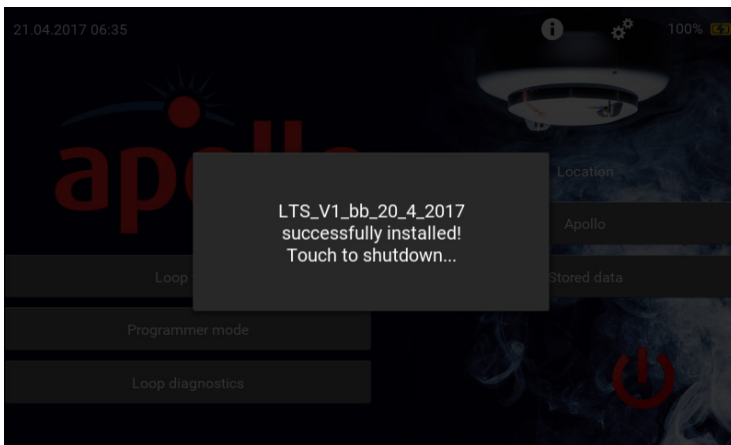

When the Firmware Update has finished uploading, the 'Successfully Installed' splash screen appears. Tap the splash screen. The Test Set powers off.

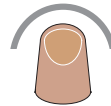

Restart the Test Set and check that the firmware has updated and the correct version has been installed. The version number can be checked by tapping the 'Settings' icon.

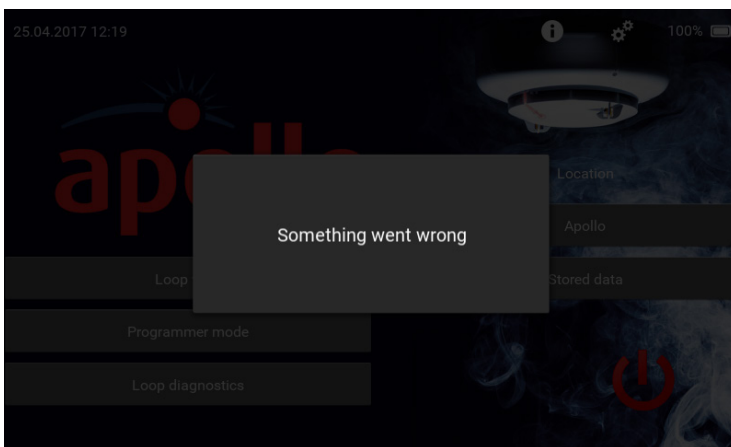

If something goes wrong during the update procedure, the message 'Something went wrong' appears.

If this happens it will be necessary to install the last stable version from the list of updates. Until the stable version is installed all menus and sub-menus (except firmware update) are disabled.

The last stable firmware update version can be found at www.apollo-fire.co.uk. This stable version should be downloaded onto the USB flash stick and the firmware update procedure repeated using this stable version.

Troubleshooting

This section contains a list of potential problems and their solutions.

- Q. I have pressed and held the power-on button, but the Test Set has not powered on.
 A. *If the power LED is illuminated, try a hard reset. If it still does not work, contact Apollo Technical Support.*
- Q. When I connect the charger the orange LED does not light to show it is connected.
 A. *a) If the charger is connected and the LED is green - the Test Set is fully charged.
 b) If the LED is red or off - check the charger is plugged into the mains supply and correctly connected to the Test Set. If the LED still does not light, replace the charger.*
- Q. The warning message 'ERROR An internal error occurred! (001)'
 A. *There has been an internal communication error. The Test Set should reset and the Home Screen appear. If this happens repeatedly, try a hard reset. If this does not solve the problem, please contact Apollo Technical Support.*
- Q. When I open a Menu or sub-menu the Test Set does not poll or show results in Loop Diagnostics.
 A. *Try a hard reset, if this does not work contact Apollo Technical Support.*
- Q. Instead of information about a device, its type, range or description, I see either a question mark or NA. Why is the information not shown?
 A. *A question mark or NA appears if the device type is not recognised, meaning it is not included in the list of devices. Please provide the device information to Apollo Technical Support.*

How do I do a hard reset?

If your Test Set is running slow, freezing, not responding or responding incorrectly, you should do a hard reset.

Press and hold the Power button for approximately eight seconds, until the power LED is lit. The device will then shut down. You will then need to restart it.

How do I replace the battery pack?

A replacement lithium-ion battery pack, Part No. 29600-795 (Apollo Test Set Battery) is available from Apollo.

To replace the battery pack:

1. Power-off the Test Set.
2. Loosen the screw on the battery compartment cover.
3. Remove the battery compartment cover.
4. Carefully remove the battery from its compartment.
5. Unclip the battery connector and dispose of the battery.
6. Clip the new battery connector in place - make sure the cable is the right way around.
7. Insert the new battery into the battery compartment.
8. Refit the battery compartment cover and secure in place using the screw.



Do not dispose of batteries in domestic waste. Correct disposal is necessary for safety and environmental reasons.

Appendix A - Menu Tree

LTS menu tree

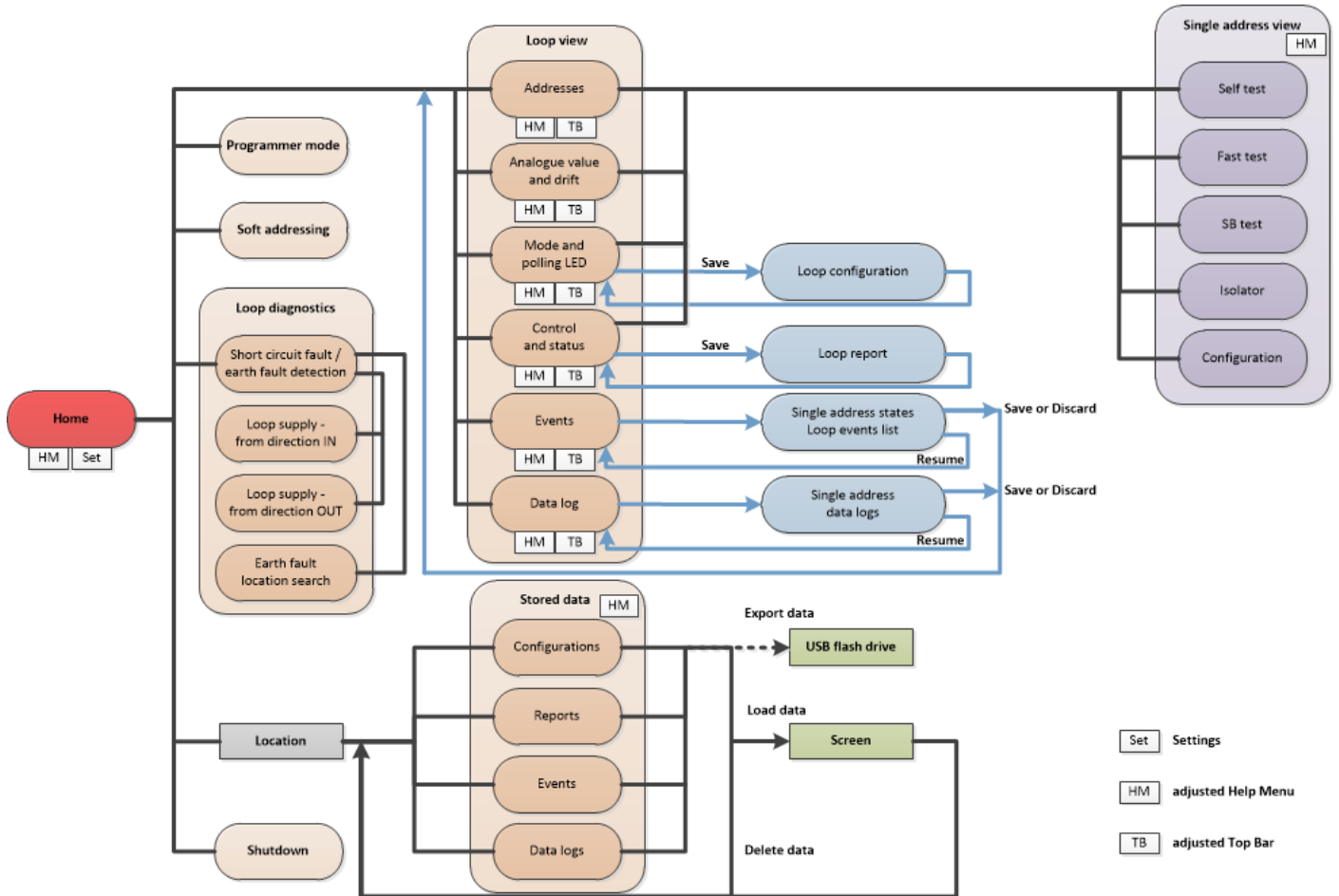

Appendix B - Soft Addressing

Soft addressing

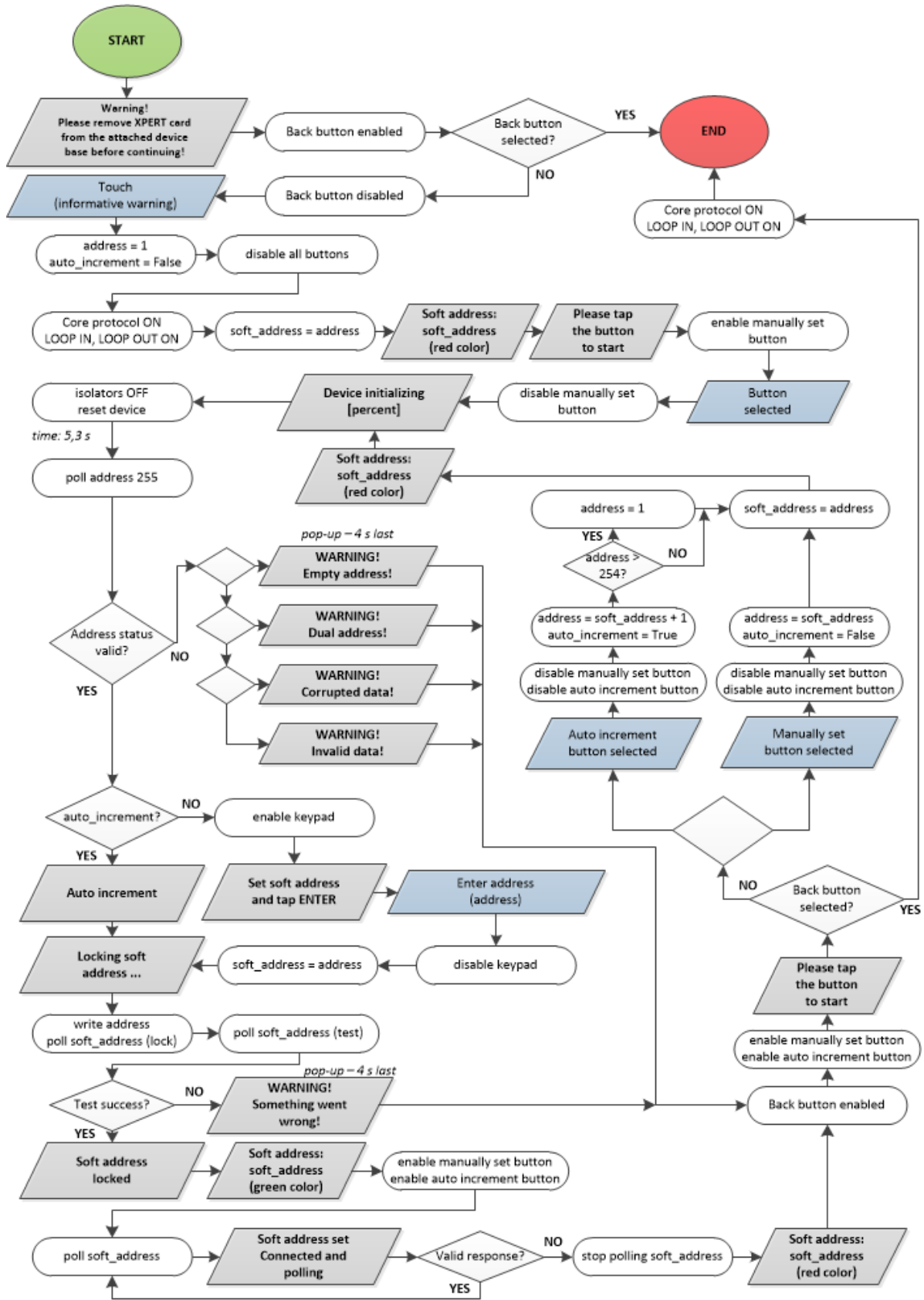

Appendix C - Short circuit and earth fault detection flowchart

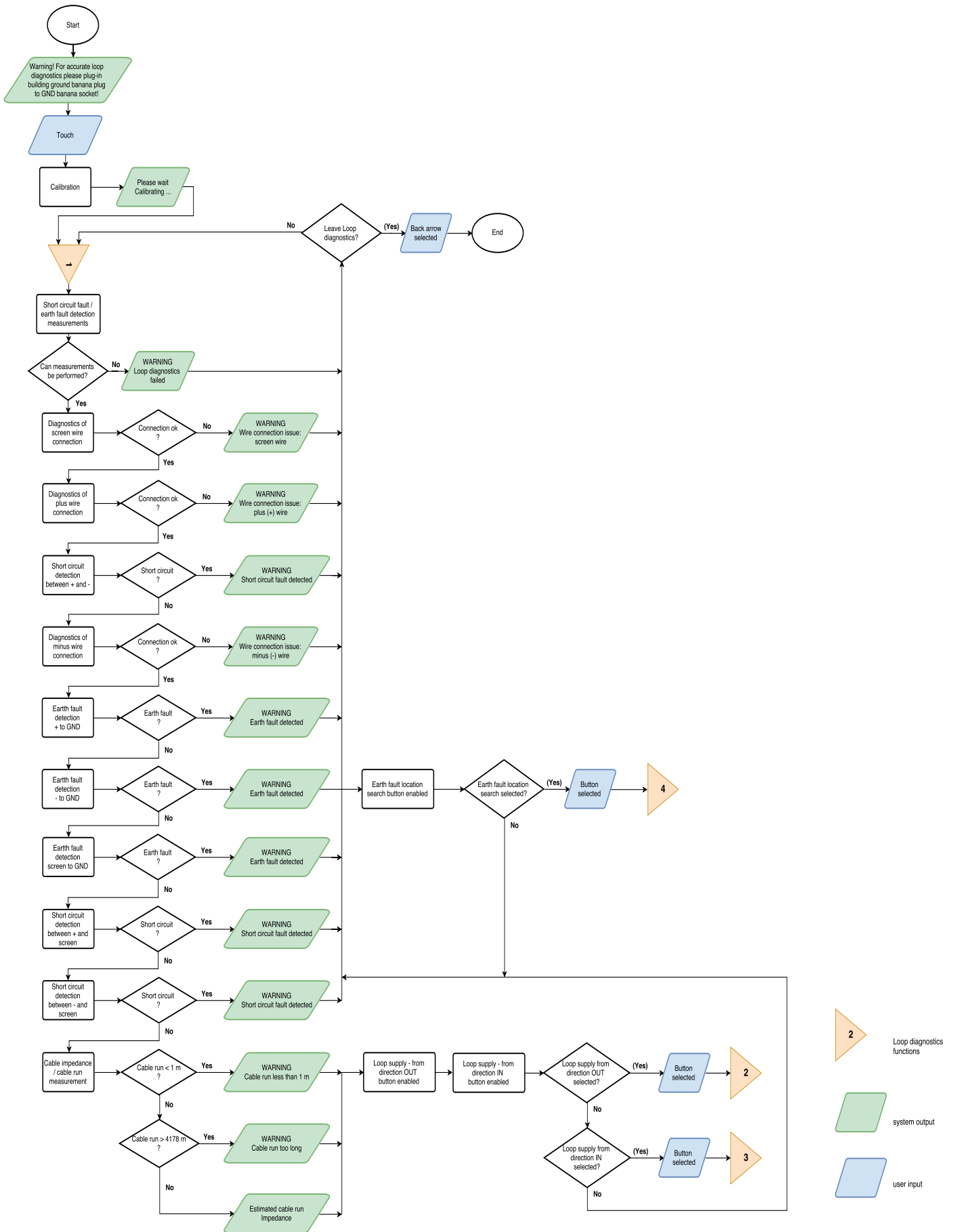

Appendix D - Loop supply from direction OUT

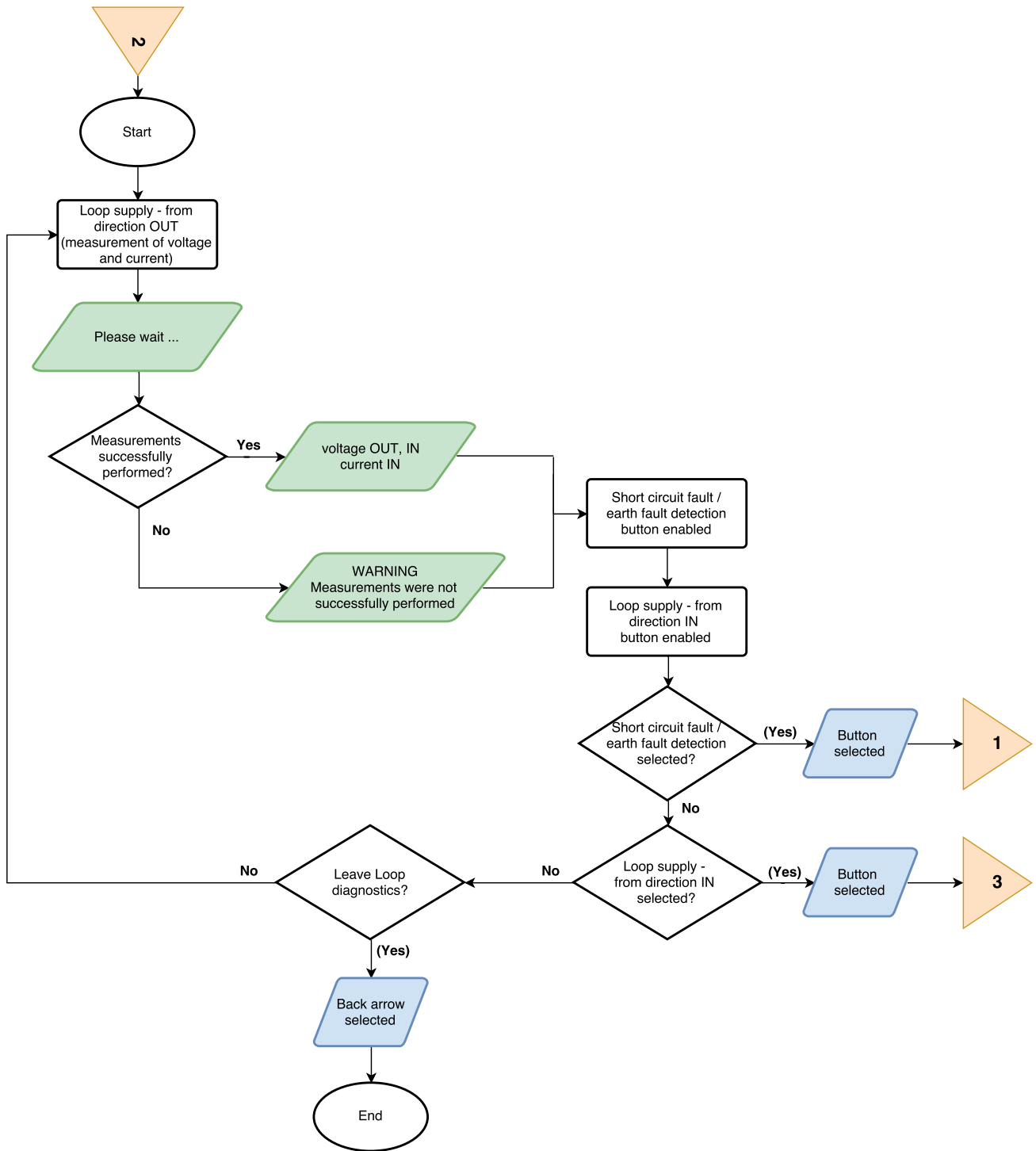

Appendix E - Loop supply from direction IN

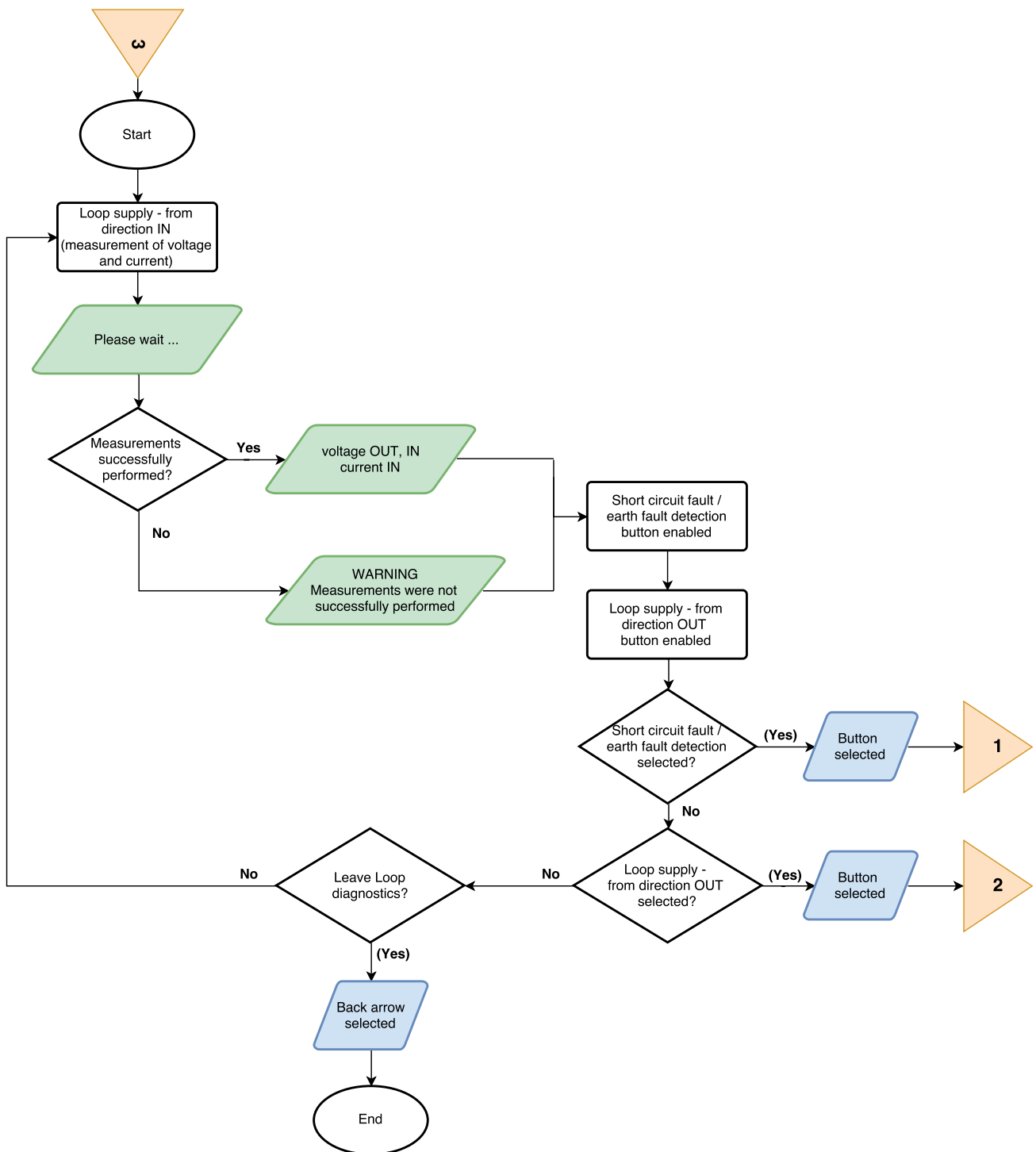

Appendix F - Earth fault location search

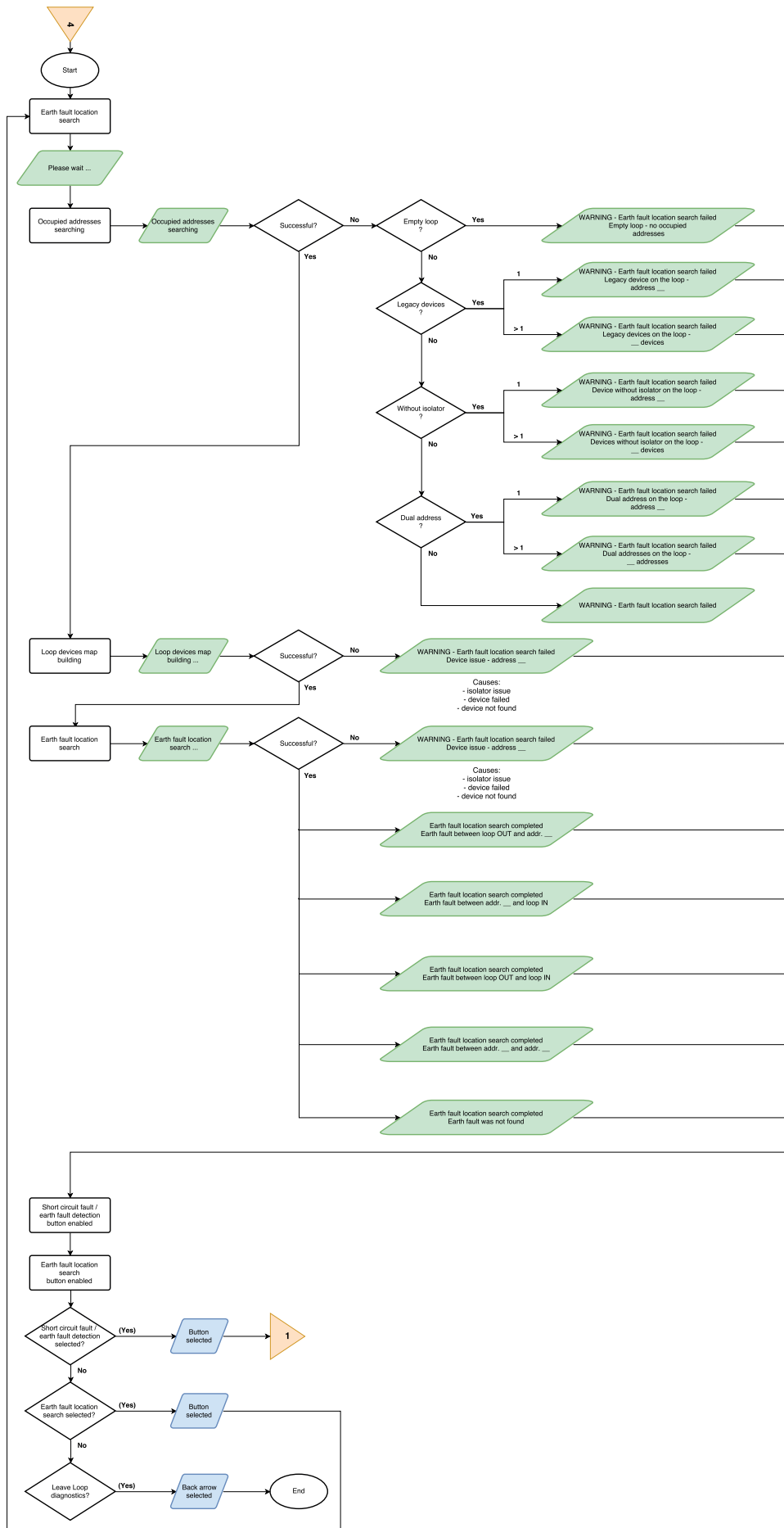

A Halma company

© Apollo Fire Detectors Ltd 2020

This page has intentionally been left blank