

MotionProtect Fibra

Wired indoor IR motion detector



The device is compatible only with hubs supporting Fibra protocol. Find the detailed information by QR code or the link:

<https://ajax.systems/support/devices/motionprotect-fibra/>



MotionProtect Fibra is the device of the new Fibra wired product line. Such devices can only be purchased, installed and administered by accredited Ajax Systems partners.

Up to 12 m detection distance

88.5° horizontal and 80° vertical viewing angles

SmartDetect software algorithm to prevent false alarms

Immunity to pets with a weight of up to 20 kg and height up to 50 cm

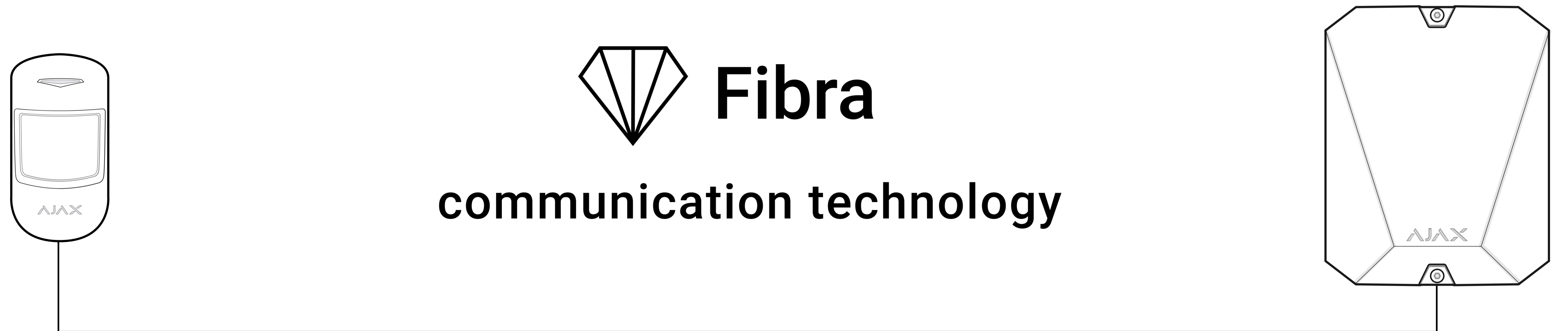

Fibra is a **two-way wired protocol**, ensuring fast and secure communication between hubs and devices. Based on a **bus connection method**, Fibra delivers instant data-rich alarms: security companies and users know which device was triggered, when and where it happened.

Fibra features **encryption** and **authentication** to prevent forgery, and **polling** to display device's status in real time. Supporting **up to 2,000 m** of wired connectivity, Fibra is ready to protect any facilities, and deliver **the best user experience** for both end users and installers.

PIR sensor viewing angles

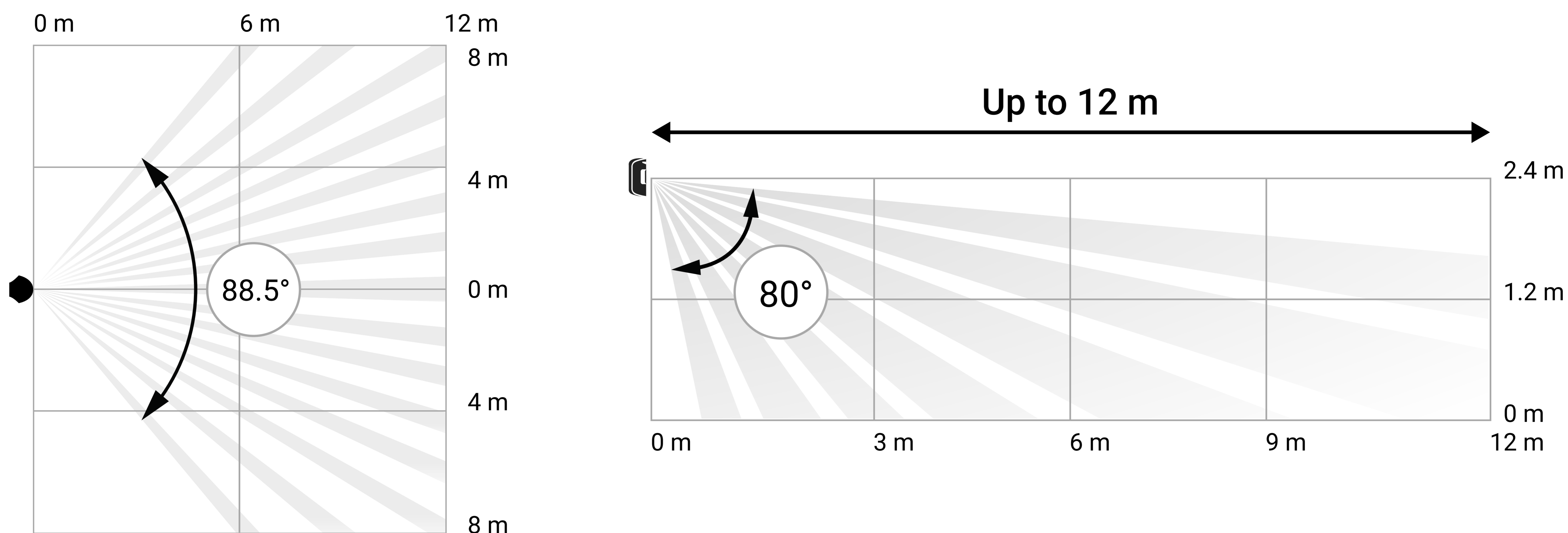

System features

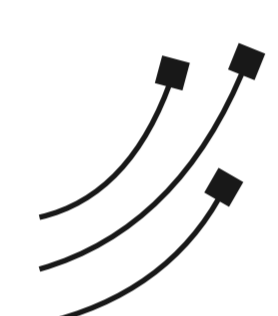

Connecting to a hub via bus method

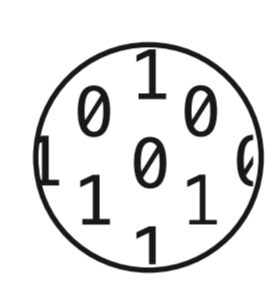

Up to 2,000 m of two-way encrypted communication

12-300
sec

Adjustable polling interval

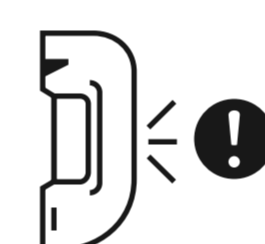

Tampering alarm notification



Remote configuring via a smartphone or desktop app

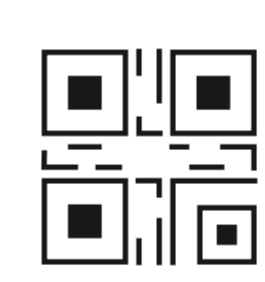

Adding to the security system via QR code or bus scanning

Technical specifications

Compliance with standards	EN 50131 (Grade 2) PD 6662:2017	Compatibility	Hubs Hub Hybrid (2G) Hub Hybrid (4G) Range extenders no
---------------------------	------------------------------------	---------------	---

<p>Communication with control panel</p>	<p> Fibra communication technology</p> <p>Communication range up to 2,000 m With U/UTP cat.5, 4×2×0.51 cable</p> <p>Polling interval 12–300 sec Adjusted by PRO or user with admin rights in the Ajax app</p> <p>Protection against forgery Device authentication</p>	<p>Motion detection</p>	<p>Sensitive element PIR sensor</p> <p>Motion detection distance up to 12 m*</p> <p>Detection angles horizontal – 88.5° vertical – 80°</p> <p>Sensitivity 3 levels Adjusted by PRO or user with admin rights in the Ajax app</p> <p>Pet immunity weight: up to 20 kg height: up to 50 cm SmartDetect software algorithm filtering false alarms</p>
<p>Power supply</p>	<p>24 V$\overline{=}$, up to 50 μA</p>	<p>Installation</p>	<p>Operating temperature range from –10°C to +40°C</p> <p>Operating humidity up to 75%</p> <p>Protection class IP50</p>
<p>Casing</p>	<p>Colour white, black</p> <p>Dimensions 110 × 67 × 62 mm</p> <p>Weight 76 g</p> <p>Tampering alarm</p>	<p>Complete set</p>	<p>MotionProtect Fibra SmartBracket mounting panel Installation kit Quick Start Guide</p>

* For INCERT compliance 10m