

MotionProtect Jeweller User Manual

Updated July 30, 2022



MotionProtect Jeweller is a wireless indoor motion detector. It can operate for up to 5 years from a built-in battery, and monitors the area within a 12-meter radius. MotionProtect ignores animals, while recognizing a human from the first step.

MotionProtect operates within the Ajax security system, connected to the [hub](#) via the protected [Jeweller](#) protocol. The communication range is up to 1700 meters in the line of sight. In addition, the detector can be used as a part of third-party security central units via the [uartBridge](#) or [ocBridge Plus](#) integration modules.

The detector is set up via the [Ajax app](#) for iOS, Android, macOS and Windows. The system notifies users of all events through push notifications, SMS and calls (if activated).

[Buy MotionProtect Jeweller](#)

Functional Elements

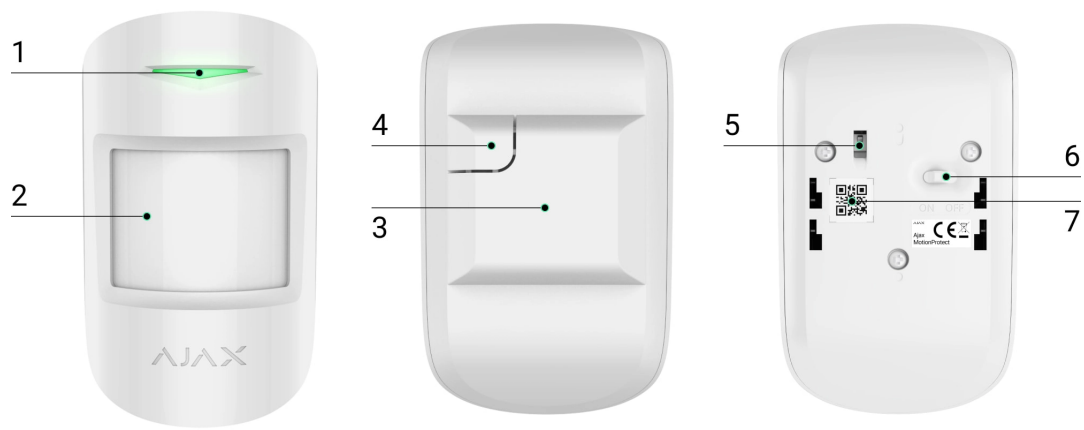

1. LED indicator.
2. Motion detector lens.
3. SmartBracket mounting panel. To remove the panel, slide it down.
4. Perforated part of the mounting panel. Necessary to trigger a tamper in case of any attempt to detach the detector from the surface. Do not break it off.
5. Tamper button. Triggers when an attempt is made to detach the detector from the surface or remove it from the mounting panel.
6. Device switch.
7. Detector QR code. Is used to connect the device to the Ajax security system.

Operating Principle

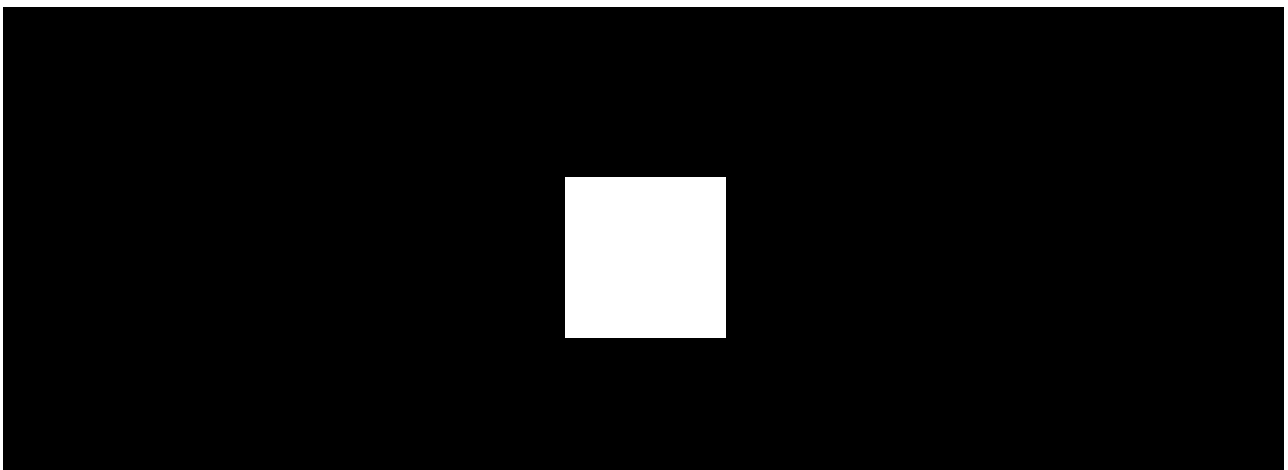

MotionProtect Jeweller is a wireless motion detector. The detector can identify intrusions by detecting moving objects with temperatures close to the human body using IR sensors.

When an armed detector identifies motion, it instantly sends an alarm to the hub, activating the sirens connected to the system, triggering scenarios, and notifying users and the security company. All MotionProtect alarms and events are recorded in the event feed of the Ajax apps.

Users know where motion is detected. The notifications contain the name of the hub (protected facility), the name of the device, and the virtual room to which the detector is assigned.

[How Ajax notifies users of alerts](#)

[More about Ajax motion detectors](#)



The detector doesn't arm instantly. The time it takes to switch to armed mode depends on exit delays (specified in the detector settings) and the hub–detector polling interval (**Jeweller** or **Jeweller/Fibra** settings, the default value is 36 seconds). In the first case, the delay is set by an administrator or a PRO-user with administrator rights. In the second case, the delay occurs because the hub takes one ping interval to notify the detector about the transition to armed mode.

Pet immunity

When properly installed and configured, MotionProtect does not react to animals up to 50 centimetres tall and weighing up to 20 kilograms.

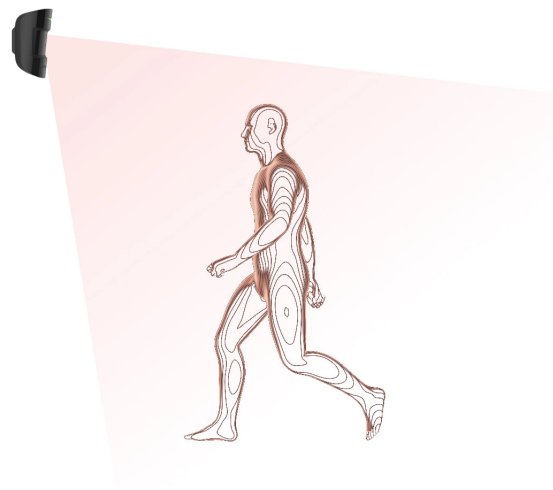
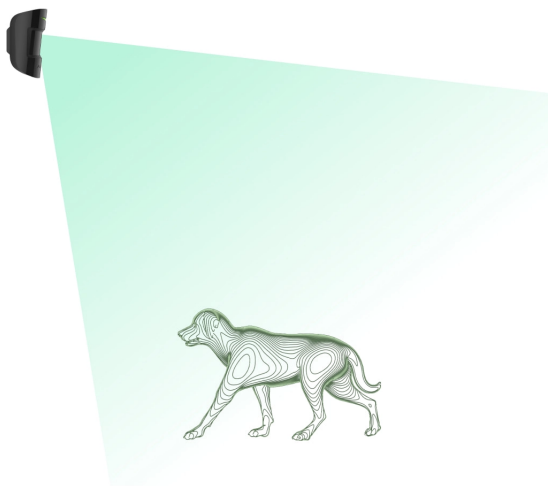

The detector must be installed at 2.4 meters without obstruction to its view. For example, in a corner where the view will not be blocked by a closet or other furniture on which a pet can climb.

It is also important to set the proper sensitivity in the detector settings:

- **High** – the detector does not react to cats (up to 25 cm tall).
- **Medium** – it does not react to small dogs (up to 35 cm tall).
- **Low** – it does not react to animals up to 50 cm tall.

When indoor motion detectors are installed below the recommended height, animals move in the hypersensitive zone. The detector can raise the alarm if a shepherd walks on its hind legs or even a tiny spaniel plays on a chair. The detector will also raise the alarm if the animal can jump to the level of MotionProtect or move near it.

Why detectors react to animals and how to avoid this

How to install MotionProtect correctly

Temperature compensation

The detector perceives people and other objects as heat spots. The device monitors these heat spots and, if they move, detects an alarm. MotionProtect reacts to the movement of heat spots whose temperature is close to the human body.

When the ambient temperature is about the temperature of the human body, the correct operation of the detector is not guaranteed unless temperature compensation is applied. It is used in all Ajax motion detectors. MotionProtect recognizes motion across the entire operating temperature range with temperature compensation.

[Learn more](#)

Sending events to the monitoring station

The Ajax security system can transmit alarms to the [PRO Desktop](#) monitoring app as well as the central monitoring station (CMS) in the formats of the **Sur-Gard protocol (Contact ID)**, **SIA (DC-09)**, **ADMECO 685**, and other proprietary protocols. A complete list of supported protocols is [available by the link](#).

[Which CMSs can the Ajax security system be connected to](#)

MotionProtect can transmit the following events:

1. Motion alarm.
2. Tamper alarm / restoration.
3. Loss / restoration of connection with the hub or radio signal range extender.
4. Temporary deactivation / activation of the detector.
5. Unsuccessful attempt to arm the security system (when [System Integrity Check](#) is enabled).

When an alarm is received, the security company monitoring station operator knows what happened and precisely where to send a fast response team on the site. The addressability of Ajax devices allows sending events to the PRO Desktop or the CMS the type of the device, its name, security group, and virtual room. Note that the list of transmitted parameters may differ depending on the kind of CMS and the selected protocol for communication with the monitoring station.



The device ID and the loop (zone) number can be found in [device states in the Ajax app](#).

Connecting to the security system

Before adding a device

1. Install an [Ajax app](#).
2. [Create an account](#) if you don't have one. Add a compatible hub to the app, make the necessary settings, and create at least one virtual room.
3. Ensure that the hub is switched on and has Internet access via Ethernet, Wi-Fi and/or mobile network. You can check the connection state in the Ajax app or by looking at the hub LED indicator. It should light up white or green.
4. Ensure that the hub is disarmed and does not start updates by checking its status in the Ajax app.

Connecting to the hub

1. Open the Ajax app. If you have access to multiple hubs or using the PRO app, select the hub where you want to add the detector.
2. Go to the **Devices**  tab and click **Add Device**.
3. Name the detector, scan or type in the QR code (placed on the detector and the package box), and select a room and a group (if [Group mode](#) is enabled).



4. Press **Add**.
5. Switch on the device.



If the connection fails, turn the detector off and try again in 5 seconds. Note that if the maximum number of devices has already been added to the hub (depending on the hub model), you will be notified when you try to add a new one.

To connect MotionProtect to the hub, the detector must be located at the same facility as the system (within the hub radio signal range). For the detector to work via the radio signal range extender, you need first add the detector and range extender to the hub, then connect it to the range extender.

The detector connected to the hub will appear in the list of hub devices in the Ajax app. Updating the statuses of devices in the list depends on the **Jeweller** or **Jeweller/Fibra** settings; the default value is 36 seconds.



The hub and the device operating at different radio frequencies are incompatible. The radio-frequency range of the device may vary by region. We recommend purchasing and using Ajax devices in the same region. You can check the range of operating radio frequencies with the [technical support service](#)

MotionProtect works with one hub. When connected to a new hub, the detector stops sending events to the old one. When added to a new hub, the detector is not removed from the device list of the old hub. This must be done through the Ajax app.

Connecting to third party security systems

To connect the detector to a third party security central unit with the [uartBridge](#) or [ocBridge Plus](#) integration module, follow the recommendations in the manuals of these devices.

Malfunctions

When a malfunction is detected (for example, there is no connection via Jeweller), the Ajax app displays a malfunction counter on the device icon. All malfunctions are shown in the detector states. Fields with malfunctions will be highlighted in red.





A malfunction is displayed if:







- The detector temperature is out of acceptable limits: below -10°C and above $+40^{\circ}\text{C}$.
- The detector enclosure is open (tamper is triggered).
- No connection with the hub or radio signal range extender via Jeweller.
- The detector battery is low.

Icons

The icons display some of the MotionProtect states. You can view them in the Ajax app in the **Devices**  tab. To access them:

1. Sign in to the [Ajax app](#).
2. Select the hub if you have several of them or using a PRO app.
3. Go to the **Devices**  tab.

Icon	Meaning
	Jeweller signal strength. Displays the signal strength between the detector and hub or range extender. The recommended value is 2 or 3 bars. Learn more
	The detector battery charge level. Learn more
	The detector is operating via a radio signal range extender .
	The detector operates in the Always active mode.

	<u>Learn more</u>
	Entry delay is enabled. <u>Learn more</u>
	Exit delay is enabled. <u>Learn more</u>
	MotionProtect will arm in Night mode . <u>Learn more</u>
	MotionProtect has detected motion. The icon is displayed when the detector is armed
	MotionProtect is temporarily disabled. <u>Learn more</u>
	MotionProtect has been deactivated due to exceeding the preset number of alarms. <u>Learn more</u>
	MotionProtect has tamper triggering events temporarily deactivated. <u>Learn more</u>

States

The states include information about the device and its operating parameters. The states of MotionProtect can be found in the Ajax app:

1. Go to the **Devices**  tab.
2. Select MotionProtect from the list.

Parameter	Value



Temperature	<p>Detector temperature. It is measured on the processor and changes gradually.</p> <p>The acceptable measurement error between the value in the app and the ambient temperature is 2°C.</p> <p>The value is updated as soon as the detector identifies a temperature change of at least 1°C.</p>
Jeweller Signal Strength	<p>Signal strength between the detector and hub or range extender on the Jeweller channel. The recommended value is 2 or 3 bars.</p> <p>Jeweller is a protocol for transmitting MotionProtect events and alarms.</p>
Battery Charge	<p>Battery level of the device. Displayed as a percentage.</p> <p>When the batteries are low, the Ajax apps and the security company will receive appropriate notifications.</p> <p>After sending a low battery notification, the detector can work for up to 2 months.</p> <p><u>How the battery charge is displayed</u></p> <p><u>Battery life calculator</u></p>
Lid	<p>The status of the detector tamper that responds to detachment or opening of the device enclosure:</p> <ul style="list-style-type: none"> • Open – the detector was removed from the SmartBracket, or detector integrity was compromised. Check the device. • Closed – the detector is installed on the SmartBracket mounting panel. The integrity of the device enclosure and the mounting panel is not compromised—normal state. <p><u>Learn more</u></p>
Delay When Entering, sec	<p>Delay time when entering: from 5 to 120 seconds.</p>

	<p>Delay when entering (alarm activation delay) is the time the user has to disarm the security system after entering the secured area.</p> <p><u>Learn more</u></p>
<p>Delay When Leaving, sec</p>	<p>Delay time when leaving: from 5 to 120 seconds.</p> <p>Delay when leaving (arming delay) is the time the user has to leave the secured area after the security system arming.</p> <p><u>Learn more</u></p>
<p>Night Mode Delay When Entering, sec</p>	<p>Delay time when entering in the Night mode: from 5 to 120 seconds.</p> <p>Delay when entering (alarm activation delay) is the time the user has to disarm the security system after entering the premises.</p> <p><u>Learn more</u></p>
<p>Night Mode Delay When Leaving, sec</p>	<p>Delay time when leaving in the Night mode: from 5 to 120 seconds.</p> <p>Delay when leaving (arming delay) is the time the user has to leave the premises after the security system arming.</p> <p><u>Learn more</u></p>
<p>ReX</p>	<p>Displays the status of using a <u>radio signal range extender</u>.</p>
<p>Connection via Jeweller</p>	<p>Connection status on the Jeweller channel between the detector and hub or the range extender:</p> <ul style="list-style-type: none"> • Online – the detector is connected to the hub or the range extender. Normal state. • Offline – the detector is not connected to the hub or the range extender. Check the device connection.

Sensitivity	<p>Sensitivity level of the motion detector:</p> <ul style="list-style-type: none"> • Low – it does not react to animals up to 50 cm tall. • Normal (by default): it does not react to small dogs (up to 35 cm tall). • High – the detector does not respond to cats (up to 25 cm tall).
Always Active	<p>When this option is enabled, the detector is constantly armed, detects motion, and raises alarms.</p> <p>Learn more</p>
Temporary Deactivation	<p>Shows the status of the device temporary deactivation function:</p> <ul style="list-style-type: none"> • No – the device operates in the normal mode. • Lid only – notifications about triggering of the tamper is turned off. • Entirely – the device is completely excluded from the system operation. The device does not follow system commands and does not report alarms or other events. • By number of alarms – the device is automatically disabled when the number of alarms is exceeded (specified in the settings for Devices Auto Deactivation). <p>Learn more</p>
Firmware	Detector firmware version.
Device ID	Detector ID. Also available on the QR code on the detector enclosure and its package box.
Device №	Number of the device loop (zone).

Settings

To change MotionProtect settings in the Ajax app:

1. Go to the **Devices**  tab.
2. Select MotionProtect from the list.
3. Go to **Settings** by clicking on the gear icon .
4. Set the required parameters.
5. Click **Back** to save the new settings.

Setting	Value
Name	<p>Detector name. It is displayed in the list of hub devices, SMS text, and notifications in the event feed.</p> <p>To change the detector name, click on the pencil icon .</p> <p>The name can contain 12 Cyrillic characters or 24 Latin characters.</p>
Room	<p>Selecting the virtual room to which the MotionProtect is assigned.</p> <p>The room's name is displayed in the SMS text and notifications in the event feed.</p>
Delay When Entering, sec	<p>Delay time when entering: from 5 to 120 seconds.</p> <p>Delay when entering (alarm activation delay) is the time the user has to disarm the security system after entering the secured area.</p> <p><u>Learn more</u></p>
Delay When Leaving, sec	<p>Delay time when leaving: from 5 to 120 seconds.</p> <p>Delay when leaving (arming delay) is the time the user has to leave the secured area after the security system arming.</p> <p><u>Learn more</u></p>
Arm in Night Mode	<p>If this option is enabled, the detector will go into the armed mode when the system is set to the</p>

	<p>Night mode.</p> <p><u>Learn more</u></p>
Night Mode Delay When Entering, sec	<p>Delay time when entering in the Night mode: from 5 to 120 seconds.</p> <p>Delay when entering (alarm activation delay) is the time the user has to disarm the security system after entering the premises.</p> <p><u>Learn more</u></p>
Night Mode Delay When Leaving, sec	<p>Delay time when leaving in the Night Mode: from 5 to 120 seconds.</p> <p>Delay when leaving (arming delay) is the time the user has to leave the premises after the security system arming.</p> <p><u>Learn more</u></p>
Alarm LED indication	<p>When the option is disabled, the LED indicator of the detector doesn't notify about alarms or tamper triggering.</p> <p>Available for devices with firmware version 5.55.0.0 and higher.</p> <p><u>How to find the firmware version of the detector</u></p>
Sensitivity	<p>Choosing the sensitivity level of the motion detector:</p> <p>The choice depends on the type of the object, the presence of probable sources of false alarms, and the specifics of the secured area:</p> <ul style="list-style-type: none"> • Low – it does not react to animals up to 50 cm tall. • Normal (by default) – it does not react to small dogs (up to 35 cm tall). • High – the detector does not react to cats (up to 25 cm tall).

	<u>Why motion detectors react to animals and how to avoid this</u>
Always Active	<p>When this option is enabled, the detector is always in the armed mode and detects motion.</p> <p><u>Learn more</u></p>
Alert with a siren if motion detected	<p>If active, <u>sirens added to the system</u> are activated when the motion is detected.</p>
Jeweller Signal Strength Test	<p>Switches the detector to the Jeweller signal strength test mode.</p> <p>The test allows you to check the signal strength between the hub or the range extender and the detector via the Jeweller wireless data transfer protocol to determine the optimal installation location.</p> <p>The recommended value is 2–3 bars.</p> <p><u>Learn more</u></p>
Detection Zone Test	<p>Switches the detector to the detection zone test mode.</p> <p>The test enables users to check how the detector responds to movement and determine the optimal installation location.</p> <p><u>Learn more</u></p>
Attenuation Test	<p>Switches the detector to the signal attenuation test mode. The test is available for detectors with firmware version 3.50 and higher.</p> <p>During the test, the transmitter power is decreased or increased to simulate a change in the environment to test the stability of communication between the detector and the hub or range extender.</p> <p><u>Learn more</u></p>
Temporary Deactivation	<p>Allows the user to disconnect the device without removing it from the system.</p>

	<p>Two options are available:</p> <ul style="list-style-type: none"> • Entirely – the device will not execute system commands or participate in automation scenarios, and the system will ignore device alarms and other notifications. • Lid only – the system will ignore only notifications about the triggering of the device tamper button. <p><u>Learn more about temporary deactivation of devices</u></p> <p>The system can also automatically disable devices when the set number of alarms is exceeded.</p> <p><u>Learn more about auto deactivation of devices</u></p>
User Guide	Opens the MotionProtect user manual in the Ajax app.
Unpair Device	Unpairs the detector, disconnects it from the hub, and deletes its settings.

Detector operation indication

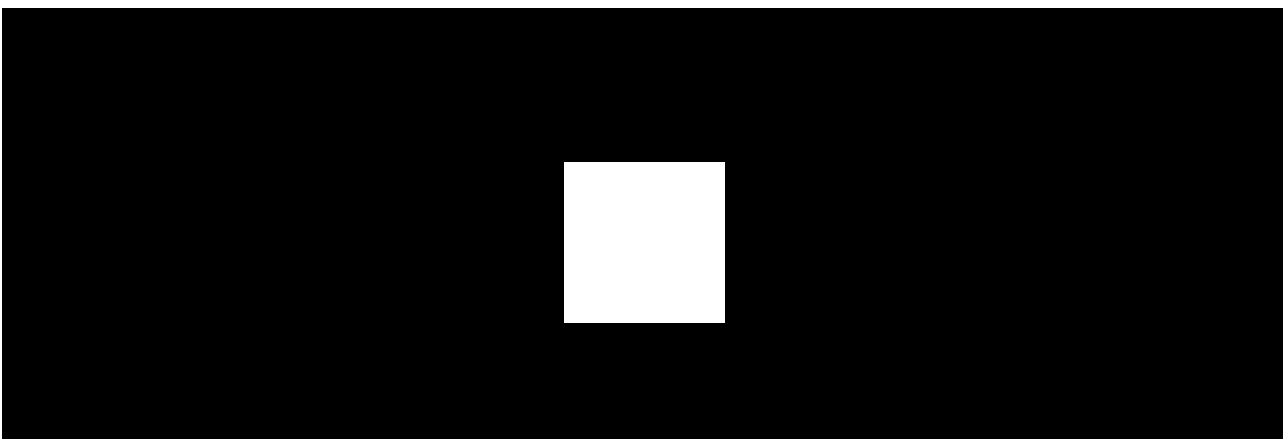

00:00

00:03



Event	Indication	Note
Turning on the detector	Lights up green for about one second	

Detector connection to the hub , ocBridge Plus and uartBridge	Lights up continuously for a few seconds	
Alarm / tamper activation	Lights up green for about one second	Alarm is sent once in 5 seconds
Battery needs replacing	During the alarm, slowly lights up and goes off green	Replacement of the detector battery is described in the Battery Replacement article

Functionality testing

The Ajax security system provides several types of tests to ensure that the installation place is chosen correctly. MotionProtect tests do not start immediately but not later than over a single hub–detector polling interval (36 seconds by default). You can change the ping interval of devices in the **Jeweller** or **Jeweller/Fibra** menu of the hub settings.

To run a test in the Ajax app:

1. Select the hub if you have several or use the PRO app.
2. Go to the **Devices**  tab.
3. Select MotionProtect from the list.
4. Go to **Settings** .
5. Select a test:
 1. [Jeweller Signal Strength Test](#).
 2. [Detection Zone Test](#).
 3. [Signal Attenuation Test](#).
6. Run the test.

Selecting the device location



The device is designed for indoor use only.

When choosing where to install MotionProtect, consider the parameters that affect its operation:



- Motion detection zone.
- Jeweller signal strength.
- Distance between the detector and the hub or radio signal range extender.
- Presence of obstacles for radio signal passage: walls, inter-floor ceilings, large objects located in the room.

The detector must be installed in the corner of the room or on a flat and not shaky vertical surface. If the device is installed on an unstable surface, this can lead to false alarms.

Consider the recommendations for placement when developing a project for the facility's security system. The security system must be designed and installed by specialists. A list of authorized partners is [available here](#).

Signal strength

The Jeweller signal level is determined by the number of undelivered or damaged data packets exchanged between the detector and a hub or range

extender in a certain period of time. The icon  on the **Devices**  tab and the corresponding field in the device **States** indicate the signal strength:

- **Three bars** – excellent signal strength.
- **Two bars** – good signal strength.
- **One bar** – low signal strength, stable operation is not guaranteed.
- **Crossed out icon** – no signal.

Check the Jeweller signal strength before permanent installation. The detector should have 2 or 3 divisions of signal strength. To roughly calculate the signal strength at the place of installation, use our [radio communication range calculator](#).

With a signal strength of one or zero bars, we do not guarantee the stable operation of the device. For such cases, consider relocating the device as repositioning even by 20 cm can significantly improve the signal strength.

If there is still a low or unstable signal after the relocation, use a [radio signal range extender](#).

Detection zone

When choosing the installation place, consider the direction of the lens, viewing angles of the detector, and the presence of obstacles impairing the view. The intended path of the intruder must be perpendicular to the axis of the detector's lens. Ensure that furniture, house plants, vases, and decorative or glass elements do not obstruct the view of the detector.

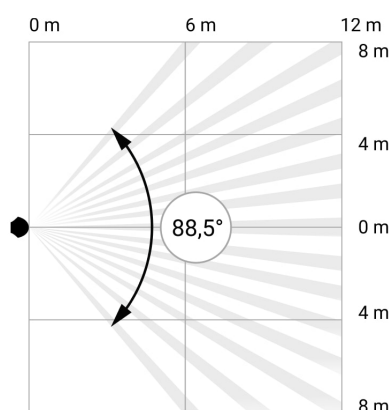

The horizontal viewing angle of the detector

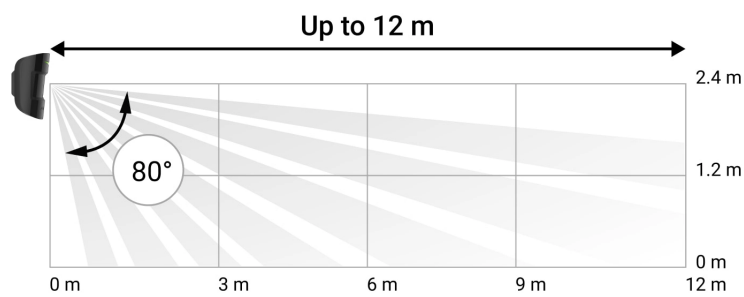

The vertical viewing angle of the detector

When installing the detector, perform the **Detection Zone Test**. This test is implemented to provide the possibility to check the device's operation and determine the sector in which the detector registers motion.

Where not to install the detector

- Outdoors. This can lead to false alarms and detector failure. We recommend using [Ajax outdoor detectors](#) for such cases.
- In the direction where direct sunlight hits the detector lens. This can lead to false alarms. We recommend using [MotionProtect Plus Jeweller](#) or [MotionProtect Plus Fibra](#) detectors for such cases.
- Opposite any objects with rapidly changing temperature like any electric or gas heater. This can lead to false alarms. We recommend using [MotionProtect Plus Jeweller](#) or [MotionProtect Plus Fibra](#) detectors for such cases.
- Opposite any moving objects with a temperature close to the human body. For example, in front of swaying curtains above a radiator. This can lead to false alarms. We recommend using [MotionProtect Plus Jeweller](#) or [MotionProtect Plus Fibra](#) detectors for such cases.
- In places with fast air circulation. For example, near fans, open windows, or doors. This can lead to false alarms. We recommend using [MotionProtect Plus Jeweller](#) or [MotionProtect Plus Fibra](#) detectors for such cases.
- In places where objects and structures can block the detector's view. For example, behind a flower or a column. In this case, the view will be limited, and it will be more difficult for MotionProtect to detect motion.
- In places where glass structures may block the detector's view. MotionProtect does not register motion behind glass.

- Inside premises with temperature and humidity outside the permissible limits. This could damage the detector. We recommend using [Ajax outdoor detectors](#) for such cases.
- At a distance of less than 1 meter from the hub or radio signal range extender. This can lead to a loss of communication with the detector.
- In places with unstable or low signal strength with the detector: 1 or 0 bars of the Jeweller signal level). This can lead to a loss of communication with the detector.

Detector installation

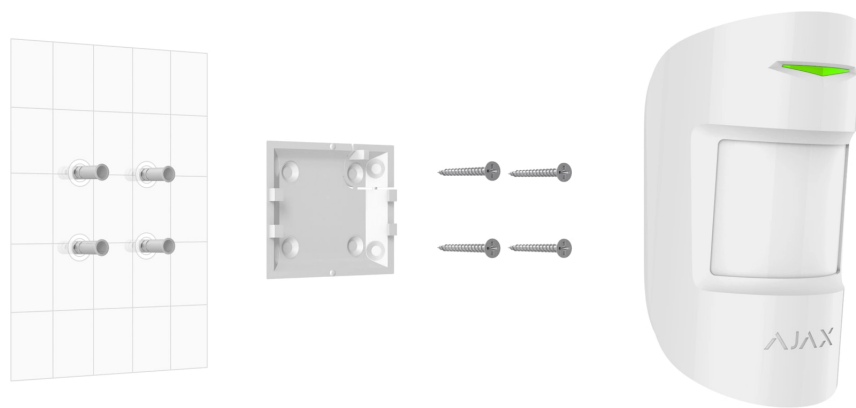

Before installing MotionProtect, ensure that you have selected the optimal location that complies with the requirements of this manual.

To mount a detector:

1. Remove the SmartBracket mounting panel from the detector by sliding it down.
2. Fix the SmartBracket panel using double-sided tape or other temporary fasteners. SmartBracket can be mounted on a vertical surface or in the corner of the room. **The installation height is 2.4 meters.**

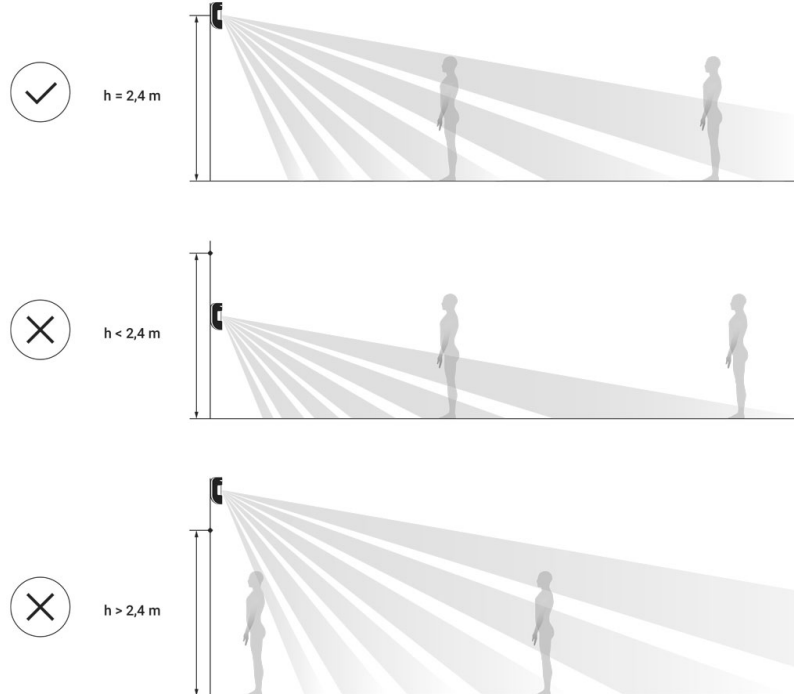

Double-sided tape can only be used for temporary installation. The device attached by the tape may come unstuck from the surface. As long as the device is taped, the tamper will not be triggered when the device is detached from the surface.

3. Mount the detector on SmartBracket.
4. Run the Jeweller signal strength test. The recommended signal strength is 2 or 3 bars. If the signal strength is low (a single bar or lower), we do not guarantee stable operation of the device. In such cases, consider relocating the device as repositioning even by 20 cm can significantly improve the signal strength. If there is still a poor or unstable signal after the relocation, use a radio signal range extender.
5. Run the Detection zone test. To check the motion detector, walk around the facility while observing the LED and determine the detector detection zone. The range of motion detection is 12 meters. If the detector did not react to movement during the test in 5 out of 5 cases, relocate the device or change its sensitivity.
6. Remove the detector from SmartBracket.
7. Attach the SmartBracket mounting panel with the bundled screws using all fixation points (one of them is in the perforated part of the mounting panel above the tamper). When using other fasteners, ensure they do not damage or deform the mounting panel.

The mounting panel allows mounting MotionProtect on a vertical surface or in the corner of a room. SmartBracket has holes to be drilled to fix the panel with the bundled screws.

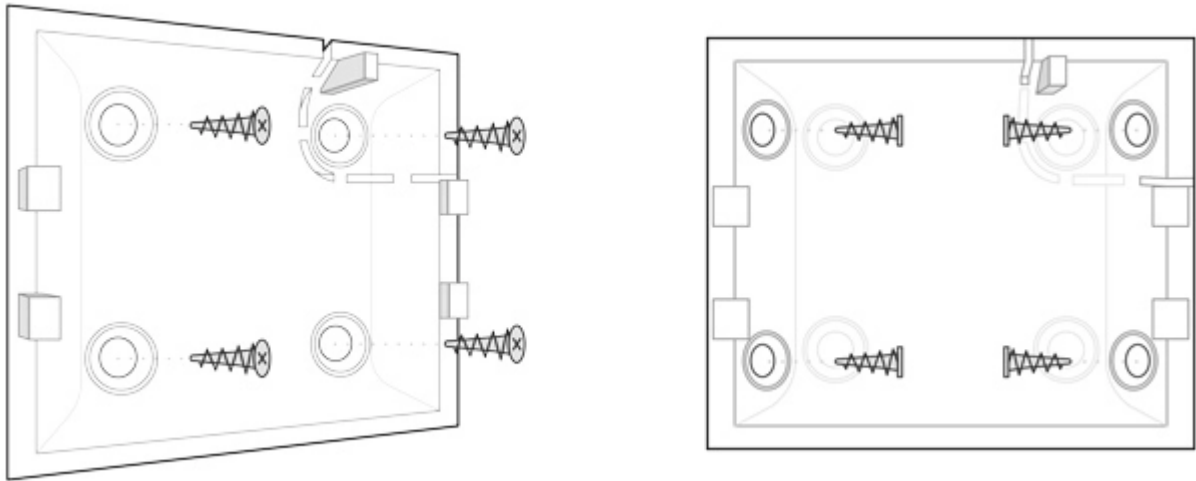

8. Place the detector on the SmartBracket mounting panel.

Detector Maintenance

Check the operational capability of the MotionProtect detector on a regular basis. The optimal frequency of checks is once every three months.

Clean the detector from dust, spider webs and other contaminants as they appear. Use a soft dry napkin suitable for equipment maintenance.

Do not use any substances containing alcohol, acetone, gasoline and other active solvents for cleaning the detector. Wipe the lens very carefully and gently – any scratches on the plastic may cause a reduction of the detector sensitivity.

The pre-installed battery ensures up to 5 years of autonomous operation (with the inquiry frequency by the hub of 3 minutes). If the detector battery is discharged, the security system will send respective notices. The LED will smoothly light up and go out if the detector detects any motion or the tamper is actuated.

[How long MotionProtect Jeweller will operate on pre-installer battery](#)

[How to replace batteries in MotionProtect Jeweller](#)

Technical specifications

Sensitive element	PIR sensor
Motion detection distance	Up to 12 m
Motion detector viewing angles (H/V)	88,5° / 80°
Time for motion detection	From 0.3 to 2 m/s
Pet immunity	Yes, height up to 50 cm, weight up to 20 kg Why motion detectors react to animals and how to avoid it >
Tamper protection	Yes
Radio communication protocol	Jeweller Learn more
Radio frequency band	866.0 – 866.5 MHz 868.0 – 868.6 MHz 868.7 – 869.2 MHz 905.0 – 926.5 MHz 915.85 – 926.5 MHz 921.0 – 922.0 MHz Depends on the region of sale.
Compatibility	Operates with all Ajax hubs , radio signal range extenders , ocBridge Plus , uartBridge
Maximum RF output power	Up to 20 mW
Modulation of the radio signal	GFSK
Radio signal range	Up to 1700 m (any obstacles absent) Learn more
Power supply	1 battery CR123A, 3 V
Battery life	Up to 5 years
Installation method	Indoors

Operating temperature range	From -10°C to +40°C
Operating humidity	Up to 75%
Overall dimensions	110 × 65 × 50 mm
Weight	86 g
Service life	10 years
Certification	Security Grade 2, Environmental Class II in conformity with the requirements of EN 50131-1, EN 50131-2-2, EN 50131-5-3

Compliance with standards

Complete Set

1. MotionProtect Jeweller.
2. SmartBracket mounting panel.
3. Battery CR123A (pre-installed).
4. Installation kit.
5. Quick Start Guide.

Warranty

Warranty for the “AJAX SYSTEMS MANUFACTURING” LIMITED LIABILITY COMPANY products is valid for 2 years after the purchase and does not apply to the pre-installed battery.

If the device does not work correctly, you should first contact the support service – in half of the cases, technical issues can be solved remotely.

Subscribe to the newsletter about safe life. No spam

Email

Subscribe