



HIKVISION

DS-3E1318P-E/DS-3E1326P-E

User Manual

UD.6L0202D2008A01

User Manual

COPYRIGHT ©2016 Hangzhou Hikvision Digital Technology Co., Ltd.

ALL RIGHTS RESERVED.

Any and all information, including, among others, wordings, pictures, graphs are the properties of Hangzhou Hikvision Digital Technology Co., Ltd. or its subsidiaries (hereinafter referred to be “Hikvision”). This user manual (hereinafter referred to be “the Manual”) cannot be reproduced, changed, translated, or distributed, partially or wholly, by any means, without the prior written permission of Hikvision. Unless otherwise stipulated, Hikvision does not make any warranties, guarantees or representations, express or implied, regarding to the Manual.

About this Manual

This Manual is applicable to DS-3E1318P-E/DS-3E1326P-E.

The Manual includes instructions for using and managing the product. Pictures, charts, images and all other information hereinafter are for description and explanation only. The information contained in the Manual is subject to change, without notice, due to firmware updates or other reasons. Please find the latest version in the company website (<http://overseas.hikvision.com/en/>).

Please use this user manual under the guidance of professionals.

Trademarks Acknowledgement

HIKVISION and other Hikvision’s trademarks and logos are the properties of Hikvision in various jurisdictions. Other trademarks and logos mentioned below are the properties of their respective owners.

Legal Disclaimer

TO THE MAXIMUM EXTENT PERMITTED BY APPLICABLE LAW, THE PRODUCT DESCRIBED, WITH ITS HARDWARE, SOFTWARE AND FIRMWARE, IS PROVIDED “AS IS”, WITH ALL FAULTS AND ERRORS, AND HIKVISION MAKES NO WARRANTIES, EXPRESS OR IMPLIED, INCLUDING WITHOUT LIMITATION, MERCHANTABILITY, SATISFACTORY QUALITY, FITNESS FOR A PARTICULAR PURPOSE, AND NON-INFRINGEMENT OF THIRD PARTY. IN NO EVENT WILL HIKVISION, ITS DIRECTORS, OFFICERS, EMPLOYEES, OR AGENTS BE LIABLE TO YOU FOR ANY SPECIAL, CONSEQUENTIAL, INCIDENTAL, OR INDIRECT DAMAGES, INCLUDING, AMONG OTHERS, DAMAGES FOR LOSS OF BUSINESS PROFITS, BUSINESS INTERRUPTION, OR LOSS OF DATA OR DOCUMENTATION, IN CONNECTION WITH THE USE OF THIS PRODUCT, EVEN IF HIKVISION HAS BEEN ADVISED OF THE POSSIBILITY OF SUCH DAMAGES.

REGARDING TO THE PRODUCT WITH INTERNET ACCESS, THE USE OF PRODUCT SHALL BE WHOLLY AT YOUR OWN RISKS. HIKVISION SHALL NOT TAKE ANY RESPONSIBILITIES FOR ABNORMAL OPERATION, PRIVACY LEAKAGE OR OTHER DAMAGES RESULTING FROM CYBER ATTACK, HACKER ATTACK, VIRUS INSPECTION, OR OTHER INTERNET SECURITY RISKS; HOWEVER, HIKVISION WILL PROVIDE TIMELY TECHNICAL SUPPORT IF REQUIRED.

SURVEILLANCE LAWS VARY BY JURISDICTION. PLEASE CHECK ALL RELEVANT LAWS IN YOUR JURISDICTION BEFORE USING THIS PRODUCT IN ORDER TO ENSURE THAT YOUR USE CONFORMS THE APPLICABLE LAW. HIKVISION SHALL NOT BE LIABLE IN THE EVENT THAT THIS PRODUCT IS USED WITH ILLEGITIMATE PURPOSES.

IN THE EVENT OF ANY CONFLICTS BETWEEN THIS MANUAL AND THE APPLICABLE LAW, THE LATER PREVAILS.

Regulatory Information



CE Mark Warning

This is a Class A product. In a domestic environment, this product may cause radio interference, in which case the user may be required to take adequate measures.

For Pluggable Equipment, the socket-outlet shall be installed near the equipment and shall be easily accessible.

WARNING: The mains plug is used as disconnect device, the disconnect device shall remain readily operable.

The Product is designed for IT Power Distribution System.

NOTE: (1) The manufacturer is not responsible for any radio or TV interference caused by unauthorized modifications to this equipment. (2) To avoid unnecessary radiation interference, it is recommended to use a shielded RJ45 cable.



FCC Statement

This equipment has been tested and found to comply with the limits for a Class A digital device, pursuant to part 15 of the FCC Rules. These limits are designed to provide reasonable protection against harmful interference when the equipment is operated in a commercial environment. This equipment generates, uses, and can radiate radio frequency energy and, if not installed and used in accordance with the instruction manual, may cause harmful interference to radio communications. Operation of this equipment in a residential area is likely to cause harmful interference in which case the user will be required to correct the interference at his own expense.

This device complies with part 15 of the FCC Rules. Operation is subject to the following two conditions: (1) This device may not cause harmful interference, and (2) this device must accept any interference received, including interference that may cause undesired operation. The manufacturer is not responsible for any radio or TV interference caused by unauthorized modifications to this equipment.

Caution!

Any changes or modifications not expressly approved by the party responsible for compliance could void the user's authority to operate the equipment.

NOTE: (1) The manufacturer is not responsible for any radio or TV interference caused by unauthorized modifications to this equipment. (2) To avoid unnecessary radiation interference, it is recommended to use a shielded RJ45 cable.

IC

CAN ICES-3 (A) /NMB-3 (A)



Safety Instruction

These instructions are intended to ensure that user can use the product correctly to avoid danger or property loss.

The precaution measure is divided into “Warnings” and “Cautions”

Warnings: Serious injury or death may occur if any of the warnings are neglected.

Cautions: Injury or equipment damage may occur if any of the cautions are neglected.

	
Warnings Follow these safeguards to prevent serious injury or death.	Cautions Follow these precautions to prevent potential injury or material damage.



Warnings

- Proper configuration of all passwords and other security settings is the responsibility of the installer and/or end-user.
- In the use of the product, you must be in strict compliance with the electrical safety regulations of the nation and region. Please refer to technical specifications for detailed information.
- Input voltage should meet both the SELV (Safety Extra Low Voltage) and the Limited Power Source with 100~240 VAC or 12 VDC according to the IEC60950-1 standard. Please refer to technical specifications for detailed information.
- Do not connect several devices to one power adapter as adapter overload may cause over-heating or a fire hazard.
- Please make sure that the plug is firmly connected to the power socket.
- If smoke, odor or noise rise from the device, turn off the power at once and unplug the power cable, and then please contact the service center.
- POE power supply does not meet the LPS, connect the power supply products must meet the fire shell requirements.

Preventive and Cautionary Tips

Before connecting and operating your device, please be advised of the following tips:

- Ensure unit is installed in a well-ventilated, dust-free environment.
- Unit is designed for indoor use only.
- Keep all liquids away from the device.
- Ensure environmental conditions meet factory specifications.
- Ensure unit is properly secured to a rack or shelf. Major shocks or jolts to the unit as a result of dropping it may cause damage to the sensitive electronics within the unit.
- Use the device in conjunction with an UPS if possible.
- Power down the unit before connecting and disconnecting accessories and peripherals.
- A factory recommended HDD should be used for this device.
- Improper use or replacement of the battery may result in hazard of explosion. Replace with the same or equivalent type only. Dispose of used batteries according to the instructions provided by the battery manufacturer.

Thank you for purchasing our product. If there is any question or request, please do not hesitate to contact dealer.

The figures in the manual are for reference only.

This manual is applicable to the models listed in the following table.

Model
DS-3E1318P-E
DS-3E1326P-E

TABLE OF CONTENTS

Chapter 1	Product Overview	7
1.1	Introduction.....	7
1.2	Package Contents.....	7
1.3	Front Panel.....	8
1.4	Rear Panel.....	9
Chapter 2	Device Installation	10
2.1	Installation Notes.....	10
	Safety Alert.....	10
	Environmental Requests.....	10
	Tools.....	11
2.2	Installation.....	11
	Rack-mounting.....	11
	Desktop-mounting.....	12
2.3	Grounding.....	13
	With grounding bar.....	13
	Without grounding bar.....	14
Chapter 3	Physical Connection	16
3.1	Connect to RJ45 Ports.....	16
3.2	Connect to SFP Combo.....	17
3.3	Check the Cabling.....	18
3.4	Connect to Power Supply.....	18
Chapter 4	Login	19
Appendix		21
	Technical Specifications.....	21
	FAQs.....	23

Chapter 1 Product Overview

1.1 Introduction

DS-3E1318P-E/DS-3E1326P-E is a 16/24-Port 10/100Mbps +2-Port Gigabit TP/SFP Combo Web Smart PoE Switch. It provides 16/24 10/100Mbps auto-negotiation RJ45 ports and 2 Gigabit TP/SFP combos.

DS-3E1318P-E/DS-3E1326P-E (Ports 1-16/24) supports IEEE 802.3af PoE (15.4W) and IEEE 802.3at PoE+ (30W) powering. The whole PoE output is 230W (DS-3E1318P-E) and 370W (DS-3E1326P-E). By using Cat 5 twisted pair, the device can provide data and power for APs, IP cameras, IP phones, and other PoE devices.

Moreover, by using Cat 5e Ethernet and enabling extend mode, the transmission distance of data and power can be as long as 250m.

In addition, DS-3E1318P-E/DS-3E1326P-E supports QVLAN, QoS, STP, SNMP, etc. You can configure and manage the device via a Web browser or SNMP. It is a perfect choose for a small and medium hotel to deploy a high performance, cost-effective and manageable networking.

1.2 Package Contents

Open your package and check the followings.

Item	Number
Switch	1
Power cord	1
Footpads	4
User Manual	1
Screws	8
L-shaped brackets	2

If any item is incorrect, missing, or damaged, please keep the original package and contact the vendor for replacement immediately.

1.3 Front Panel

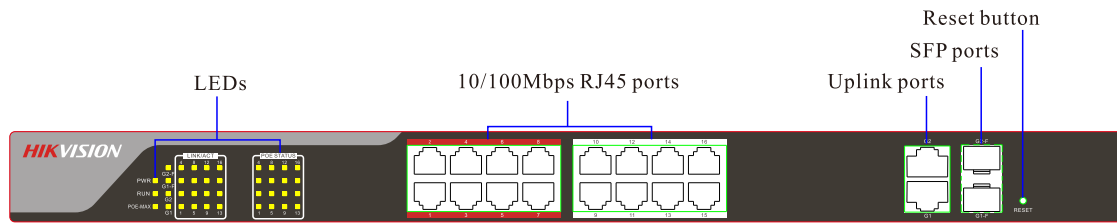

Figure 1.1 DS-3E1318P-E

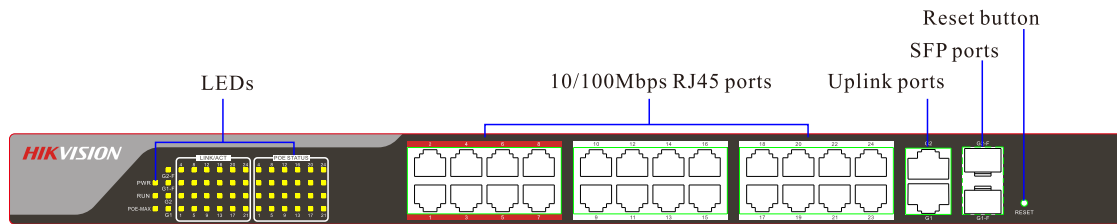

Figure 1.2 DS-3E1326P-E

Table 1.1 Description of LED

LED	Status	Description
PWR	Solid	The device is connected to the power supply properly.
	Off	The device is connected improperly or not connected to the power supply.
RUN	Solid/Off	The device system works improperly.
	Blinking	The device system is running properly.
LINK/ACT	Solid	The corresponding port is connected properly.
	Blinking	The corresponding port is transmitting data.
	Off	The corresponding port is connected improperly or not connected.
POE STATUS	Solid	The corresponding port is connected with a PD (Powered Device) and powers the PD properly.
	Blinking	The PoE output of the corresponding port exceeds 30W.
	Off	The corresponding port is no PoE power output or no PD connected.
POE-MAX	Solid	The PoE power gets to the alarm value, and the available PoE power is less than 6W.
	Blinking	The PoE power gets to the maximum.
	Off	The PoE power works properly, and the available PoE power is more than 6W.
G1/G2	Solid	The corresponding port is connected.
	Blinking	The corresponding port is transmitting data...
	Off	The corresponding port is connected improperly or not connected.
G1-F/G2-F	Solid	The corresponding port is connected properly.
	Off	The corresponding port is connected improperly or not connected.

*If G-F port (G1-F/G2-F) is connected, LEDs of G (G1/G2) ports will not light.

✎ RJ45 ports & SFP combos

Model	10/100Mbps RJ45 ports	10/100/1000Mbps RJ45 ports	1000Mbps SFP combos (G1-F/G2-F)
DS-3E1318P-E	16	2	2
DS-3E1326P-E	24	2	2

Note that:

1. Ports 1-8 are with high priority by default, which take advantage over other ports to process key data or video data.
2. Ports 1-16/24 support IEEE 802.3af and IEEE 802.3at PoE power;
3. When SFP combos (G1-F/G2-F) and G1/G2 port are connected, SFP combos will get priority over G1/G2 to work.
4. Optional module is not included in the device packaging. Please prepare by yourself if needed.

✎ Reset button

When the device is powered up, hold the button with a needle for 6 seconds till the RUN LED starts blinking again (in 20 seconds), and the device will be reset to factory default settings.

1.4 Rear Panel

The rear panels of DS-3E1318P-E/ DS-3E1326P-E are similar. Here take DS-3E1326P-E as a guide.

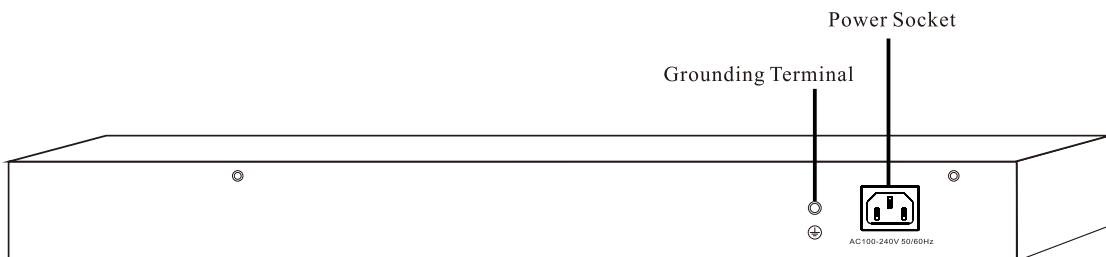

Figure 1.2 DS-3E1326P-E

✎ Power Socket

Used for connecting the included power cord for power supply. Please use the included power cord to connect the device to power supply.

✎ Grounding Terminal

Used for connecting the grounding cable for lightning-resisting. The grounding details refer to Section [2.3 Grounding](#)

Chapter 2 Device Installation

(Here DS-3E1326P-E is taken as an installation guide, which applies to DS-3E1318P-E.)

2.1 Installation Notes

To guarantee the device long service and your personal safety, please follow notes below.

Safety Alert

- Wear antistatic gloves while installing, and connect the device to power after finishing other installation.
- Use the included power cord to power the device.
- Make sure the input voltage matches the value which is marked on the device's label.
- Place the device in a well-ventilated and dry environment.
- Do not open the cabinet of the device.
- Disconnect the device from the power supply when you are to do the cleaning.
- Position the device away from strong current.



Cautions

There is a seal covering one of the screws in the case of the device. In case of need repair, keep the seal unbroken until the agent supervise the maintenance. The user should not break the seal of the coverage without permission of the local agent, otherwise will be responsible for any damage.

Environmental Requests

Temperature/Humidity

Item	Temperature	Humidity
Operation Environment	0°C - 40°C	10% - 90% RH (non-condensing)
Storage Environment	-40°C -70°C	5% - 90% RH (non-condensing)

Antistatic Precautions

Dust may lead to electrostatic adsorption. To protect the device from static electricity harm, please pay attention to the following:

- Keep the device environment air clean. (A regular dusting is necessary)
- Make sure the device is grounded well.

⚡ Lightning Protection

In a thunderstorm weather, a sudden current may damage the device. To protect the device from lightning stroke or strong current, please:

- Make sure the device, the installation desktop/rack and power outlet on the wall all are well-grounded.
- Cable the device properly; and if you need to cable outdoors, it is advisable to set up with a signal lightning arrester.

⚡ Mounting Standards

No matter whether it is rack-mounting or desktop-mounting, follow the instructions below.

- The rack/desktop is stable and sturdy enough.
- Place the device in a clean, dry and well-ventilated environment. Keep at least 10cm free on all sides for cooling.
- Do not place any heavy or big size object on the device.
- Keep at least 1.5cm vertical distance between each device while installing it in stack.

Tools

Things you'll need but should be prepared by yourself.

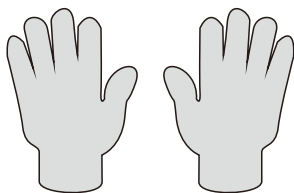

Antistatic Gloves

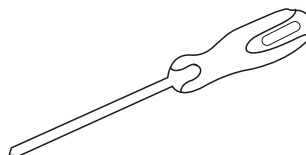

Phillips Screwdriver



Ethernet Cable

Figure 2.1 Installation Tools

2.2 Installation

The device supports two types of installation: rack-mounting and desktop-mounting. Install your device according to the tools you have.

Rack-mounting

You can install the device in a standard 19-inch rack with the accessories (L-shaped brackets and screws) come with the box.

- 1) Fix the rack on the ground, stable and level; and ground the device well.
- 2) Fix L-shaped brackets to the device with screws. (Shown as below)

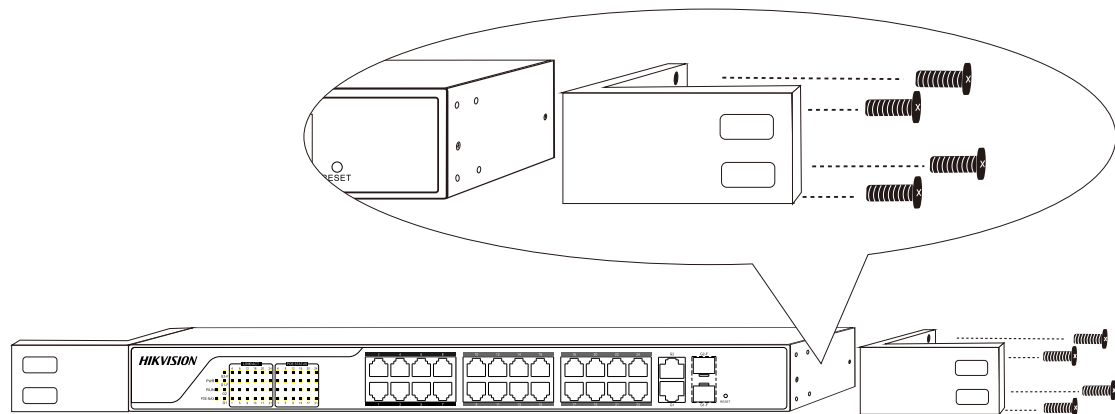

Figure 2.2 L-shaped bracket installation

- 3) Adjust the device to a nice height and fix the device to the rack with screws (self-prepared). (Shown as below)

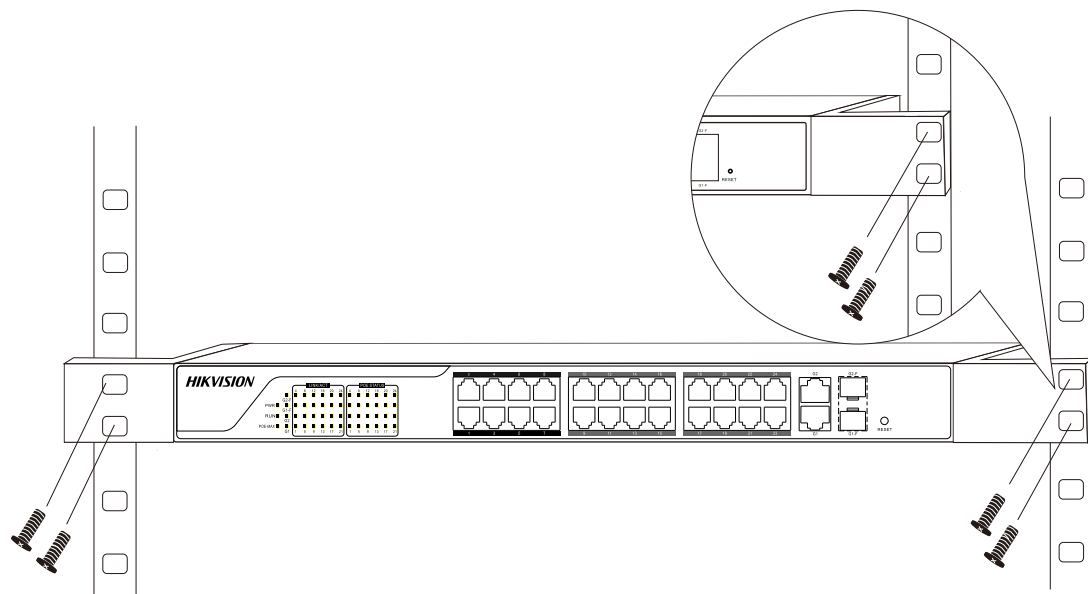

Figure 2.3 Fix to the rack

Desktop-mounting

Also, you can install the device on a desktop.

- 1) Place the device bottom up on a stable and flat desktop.
- 2) Paste the four footpad stickers to the corresponding four corners of the device bottom.

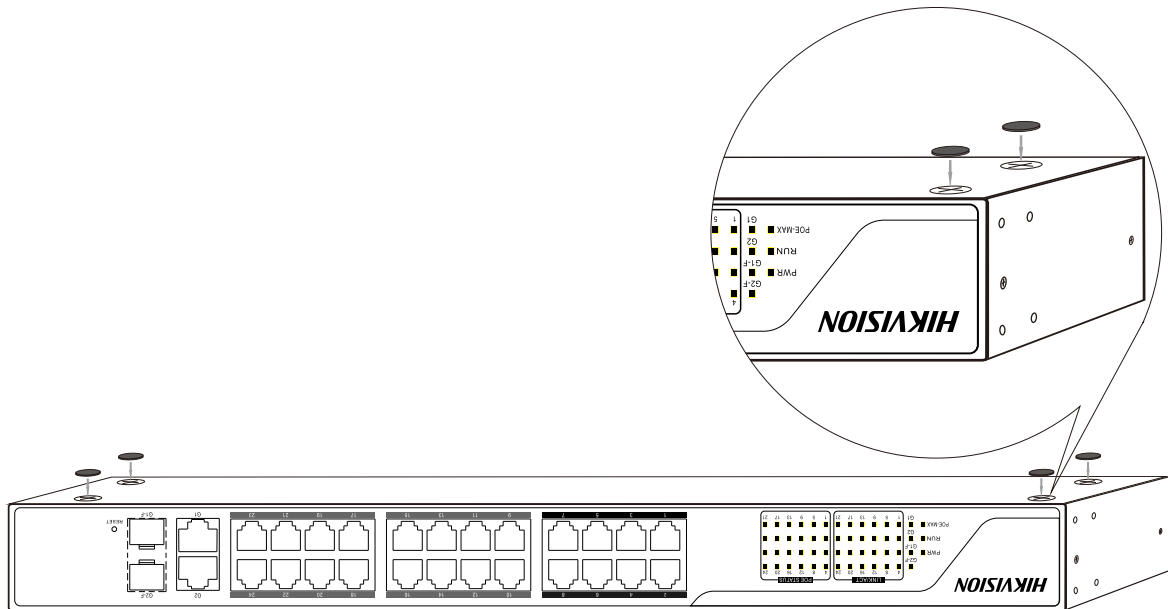

Figure 2.4 Paste the footpads

3) Then place the device correctly on the desktop.

2.3 Grounding

Grounding is not only important for lightning arresting and anti-interference, but for your own personal safety. Please select the proper method to ground your device.

With grounding bar

If a grounding bar is available at the installation site, follow either of the two installations to ground the device.

A. Connect to the Grounding Bar Directly

- 1) Connect one end of the grounding cable to the binding post on the grounding bar.
- 2) Connect the other end of the grounding cable to the grounding terminal and fix the screw.

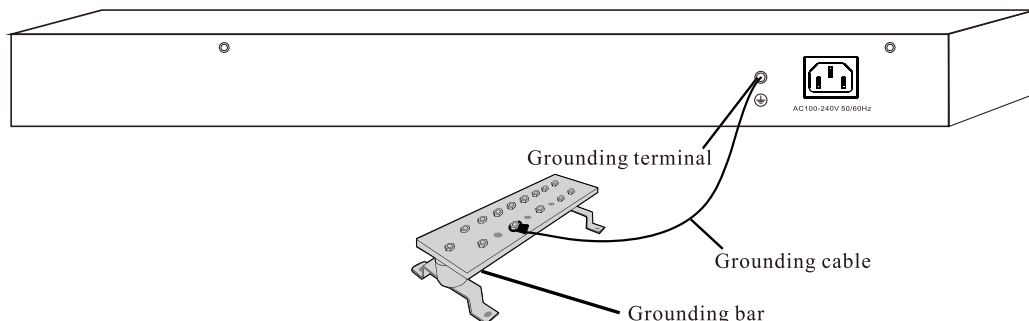

Figure 2.5 Connect to the grounding bar

B. Connect to another grounded device

- 1) Connect one end of the grounding cable to the grounding terminal of the grounded device and fix the screw.

2) Connect to the other end of the grounding cable to the grounding terminal of the device and fix the screw.

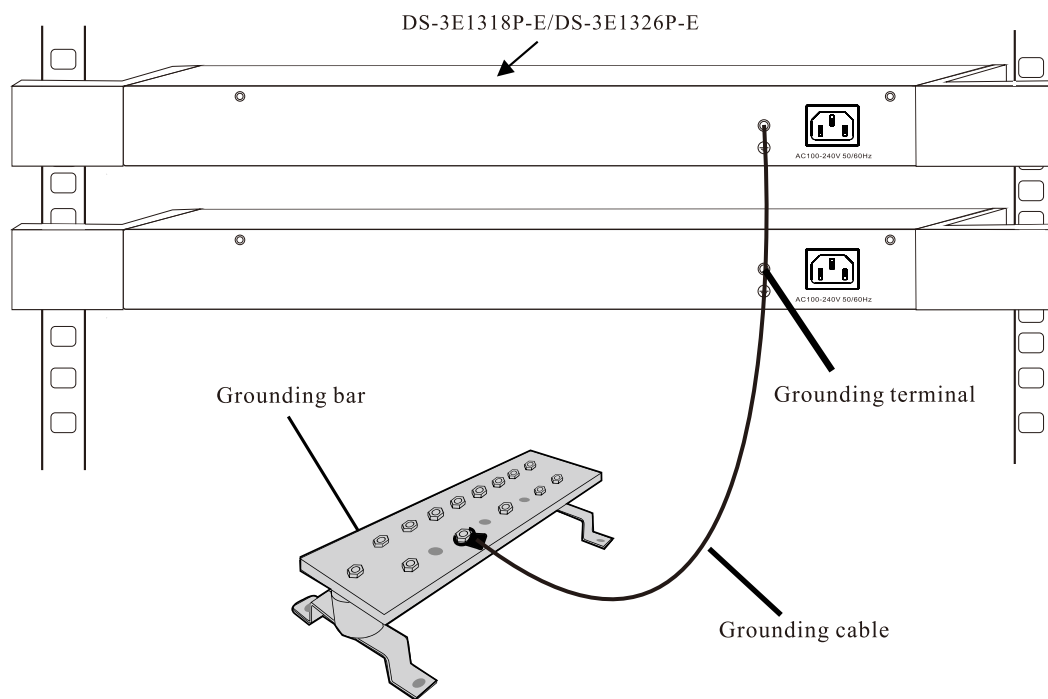

Figure 2.6 Connect to a grounded device



Cautions

Connect the grounding cable to the earthing system in the equipment room. Do not connect it to a fire main or lightning.

Without grounding bar

■ If there is no ground bar but earth nearby and the grounding body is allowed to be buried, follow below steps:

- 1) Bury an angle steel or steel pipe ($\geq 0.5\text{m}$) into the mud land.
- 2) Weld one end of the grounding cable to the angle steel or steel pipe and embalm the welding point.
- 3) Connect the other end of the grounding cable to the grounding terminal and fix the screw.

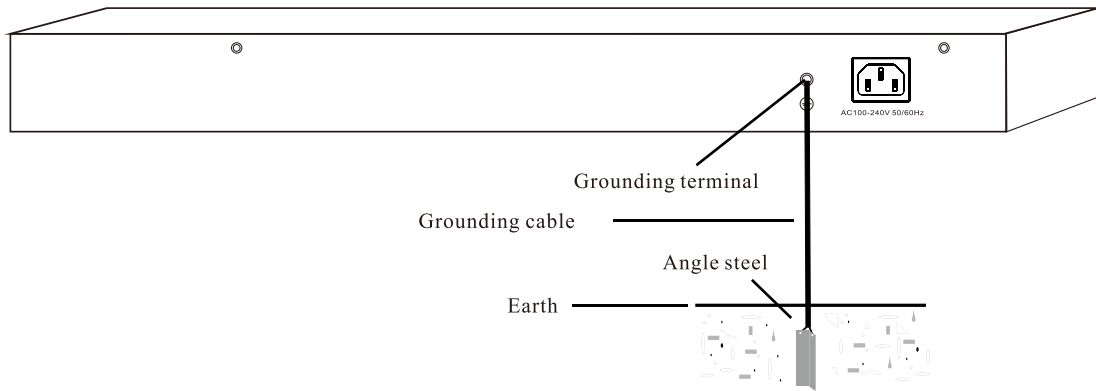

Figure 2.7 Ground with an angle steel

- If both ground bar and the conditions for burying the grounding body are not available, an AC-powered Ethernet switch can be grounded using the PE (Protecting Earth) wire of the AC power supply.

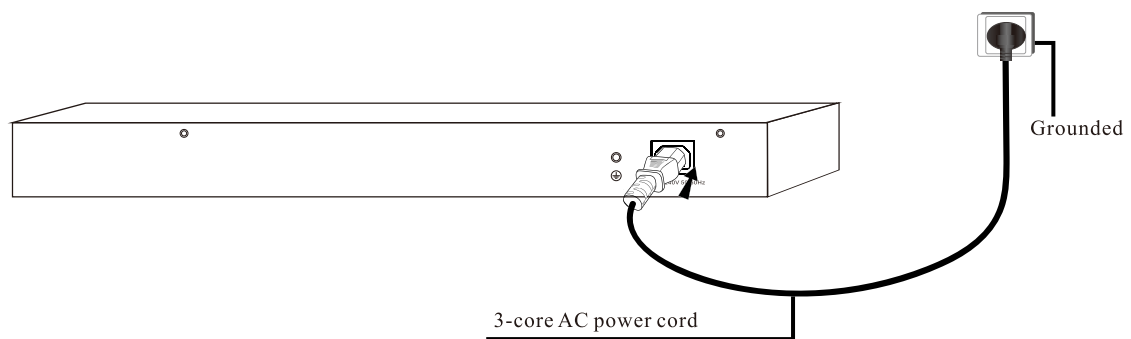

Figure 2.8 Ground with 3-core AC power cord



Cautions

Make sure that the PE wire of the AC power supply has been well grounded at the side of the power distribution room or AC power supply transformer.

Chapter 3 Physical Connection

3.1 Connect to RJ45 Ports

Connect the switch to a remote device with Ethernet cable via RJ45 port. G1 and G2 are uplink ports. Ports 1-16/24 support IEEE 802.3af and IEEE 802.3at PoE supply, and the PD can be wireless AP, IP phone or IP camera, etc. By default, PoE features of Ports 1-16/24 are enabled.

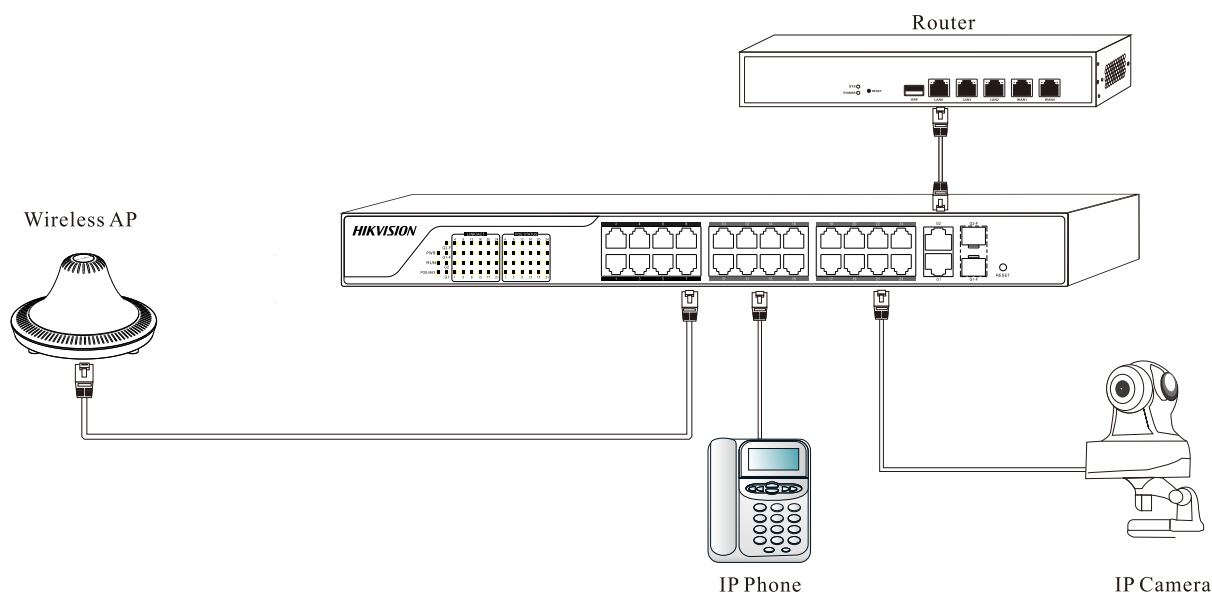

Figure 3.1 RJ45 port connection

Note that:

1. Cat 5e or better Ethernet cable is recommended. As each RJ45 port supports MDI/MDIX auto-negotiating, either parallel or crossover cable is available.
 2. The device supports dynamic PoE supply. Namely, the device will power the PD properly and automatically.
-

3.2 Connect to SFP Combo

1) Insert your optical module into the SFP port (G1-F/G2-F).

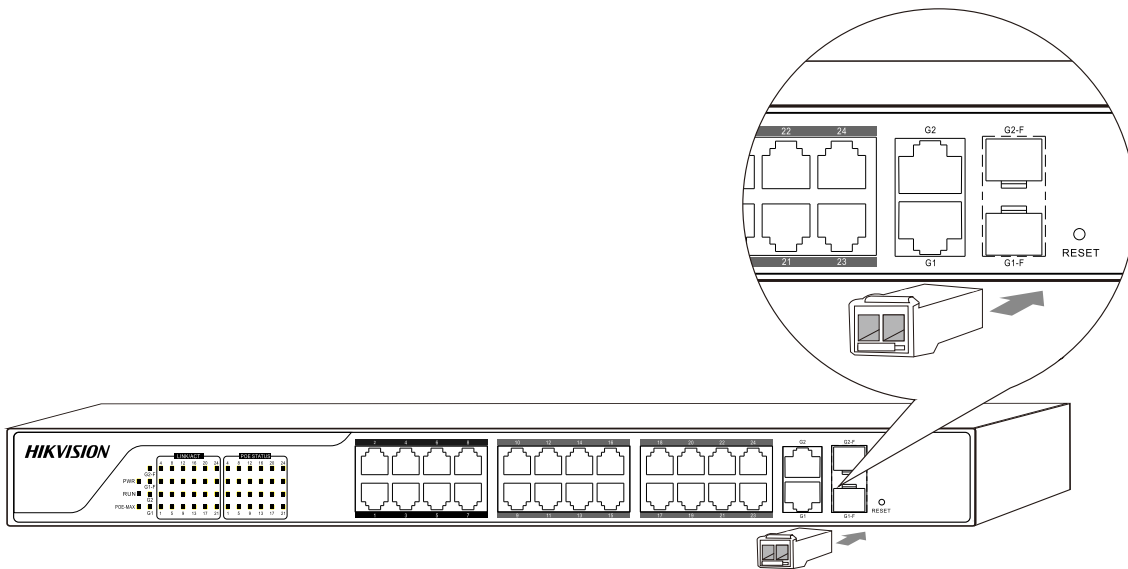

Figure 3.2 Insert optical module

2) Insert the remote optical fiber to the module correctly. (RX fiber into the port labeled RX on the module; and TX fiber into the TX)

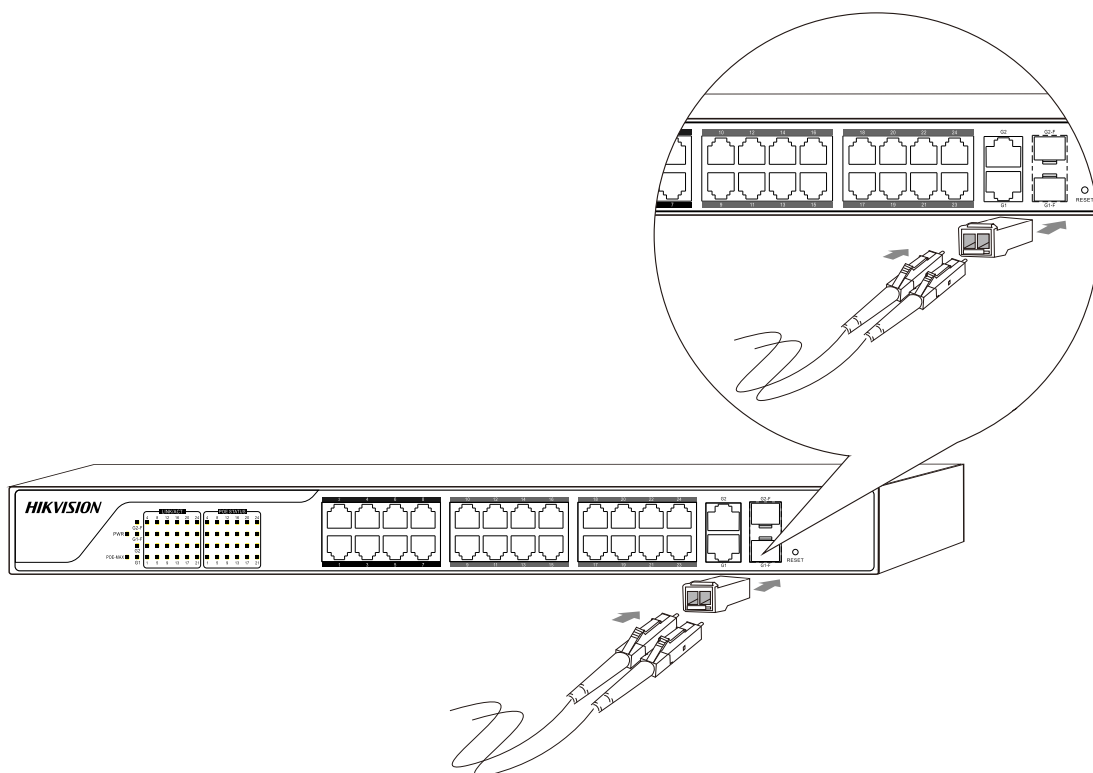

Figure 3.3 Insert optical fiber

3.3 Check the Cabling

Once installation is completed, check the cabling of the device as the following:

- The operating power supply should accord with rated input standard.
- Ports cablings and grounding cable are correctly connected.
- If there is outdoor cabling, connect a lightning protector to the cable before you plug the cable into the port.

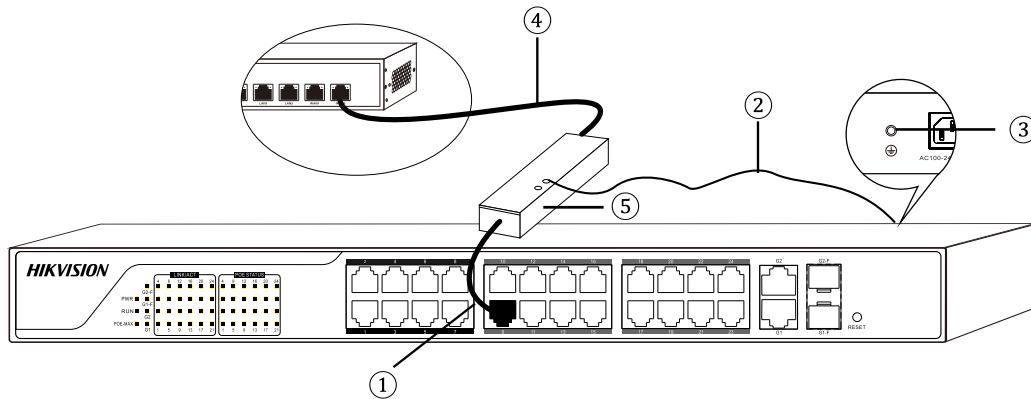

Figure 3.4 Lightning protector connection

- | | | |
|-------------------|----------------------|-----------------------|
| ① Ethernet cable | ③ Grounding terminal | ⑤ Lightning protector |
| ② Grounding cable | ④ Outdoor cabling | |

3.4 Connect to Power Supply

Please use the included power cord for power supply.

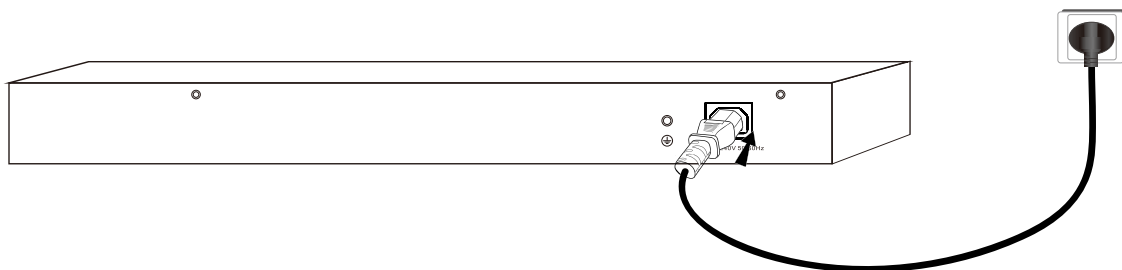

Figure 3.5 Power connection

Chapter 4 Login

1) Connect a PC to the device via RJ45 port using an Ethernet cable.

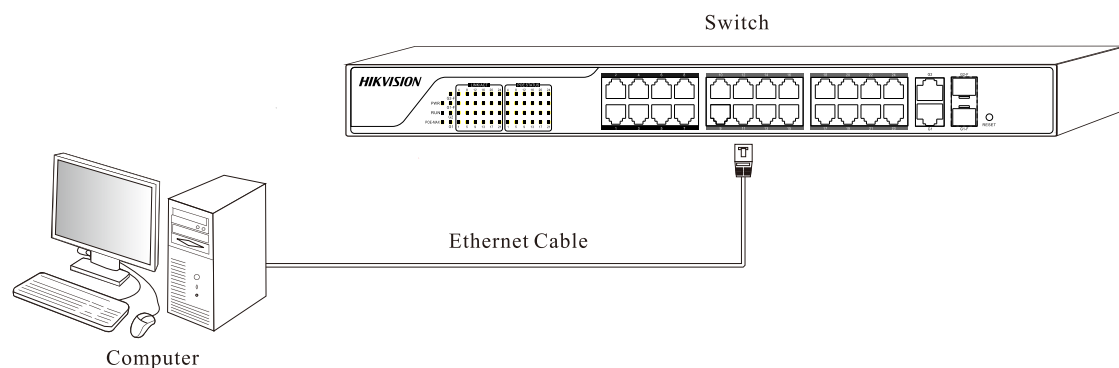

Figure 4.1 Switch and computer connection (take DS-3E1326P-E as an example)

2) Configure the local PC IP address as 192.168.0.x (“x” can be any number in 2-254), subnet mask as 255.255.255.0.

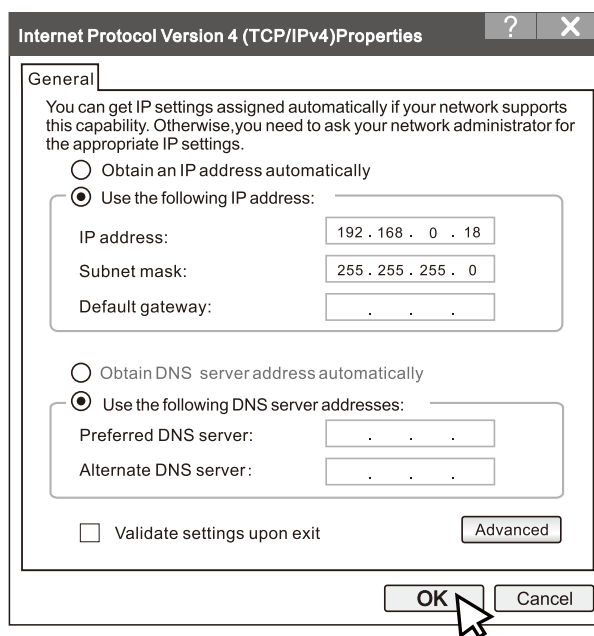

Figure 4.2 Computer IP settings

3) Launch a Web browser; type “192.168.0.1” (without quotes) in the address bar and hit “**Enter**” on the keyboard.

4) That will direct you to the device login page, prompting you to enter the username (admin) and password (admin), and click **Login**.

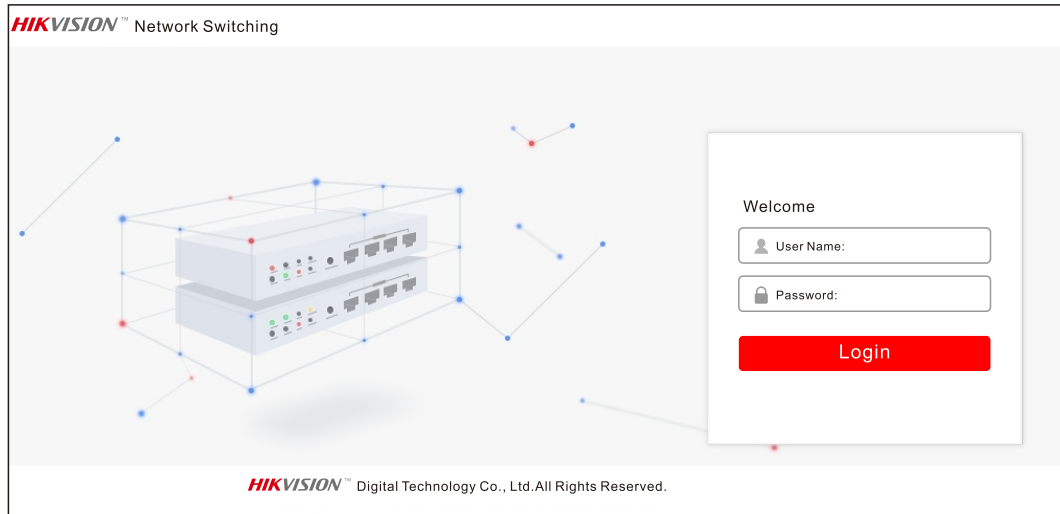

Figure 4.3 Login

5) Now, you have entered the device home page, and you can set up the device parameters as needed.

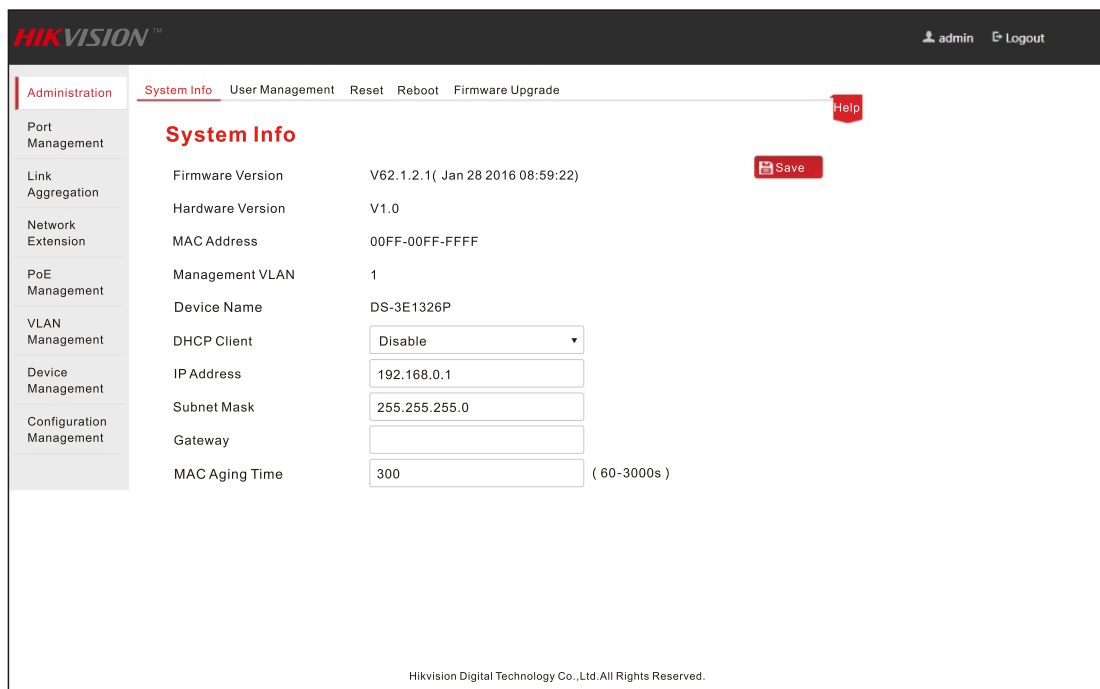

Figure 4.4 User Interface

Appendix

Technical Specifications

Hardware Specifications

Item		DS-3E1326P-E	DS-3E1318P-E
Interfaces	10/100Mbps RJ45	24	16
	10/100/1000Mbps RJ45	2 (G1, G2)	2 (G1, G2)
	1000Mbps SFP	2 (G1-F, G2-F)	2 (G1-F, G2-F)
	High priority ports	1-8	1-8
Performance	Store-and-forward	Supported	
	MAC Table	4k	4k
	MAC Learning	Auto-learning/ Auto-aging	
	Switching Capacity	8.8Gbps	7.2Gbps
PoE Power	PoE standard	IEEE 802.3af, IEEE 802.3at	
	PoE Powering Mode	Supports 8 pins powering, which means pins 1,2,3,6 and pins 4,5,7,8 can power simultaneously	
	PoE Port	1-24	1-16
	Max Port Output	30W	30W
	Max Total Output	370W	230W
Lightning-proof Ranking	RJ45 port lightning proof	4KV	
	Power source lightning proof	6KV	
Power Input		100-240V AC, 50/60Hz	
Physical Environment	Operating Environment	Temperature: 0°C-40°C Humidity: 10%-90% RH non-condensing	
	Storage Environment	Temperature: -40°C-70°C Humidity: 5%-90% RH non-condensing	
Transmission Speed		Ethernet: 10Mbps (Half Duplex) / 20Mbps (Full Duplex) Fast Ethernet: 100Mbps (Half Duplex) / 200Mbps (Full Duplex) Gigabit Ethernet: 2000Mbps (Full Duplex)	
Transmission Medium		Ethernet: Cat 3 or better UTP/STP Fast Ethernet: Cat 5 or better UTP/STP Gigabit Ethernet: Recommended to use Cat 5e or Cat 6 UTP/STP 1000Base-SX: MMF (Multimode optical fiber) 1000Base-LX: MMF (Multimode optical fiber) or SMF (Single Mode Fiber)	
Network Standard		IEEE 802.3, IEEE 802.3u, IEEE802.3ab, IEEE 802.3af, IEEE802.3at, IEEE 802.3x, IEEE802.3z	

Software Specifications

Item	Specification
Extend Mode	Enabling extend mode can extend the data (10Mbps half/full duplex supported) and powering transmission distance to 250m by using Cat 5e or better Ethernet cable.
PoE	Supports IEEE 802.3at / IEEE 802.3af PoE powering standard. Supports port PoE enabling/ disabling. Supports PoE temperature protecting. Supports PoE powering status and output display. Supports dynamic PoE powering; the default port powering priority is (Port 1 > Port 2 > Port3 >...> Port 24).
MAC Binding	Supported
VLAN	One-click VLAN (VLAN quick division) Up to 18/26 groups of port VLAN Up to 31 groups of IEEE 802.1Q VLAN
Port Trunk	Three groups: (Ports 1, 2, 3, 4) (Ports 5, 6, 7, 8) (G1/G1-F and G2/G2-F)
STP	IEEE 802.1d STP IEEE 802.1w RSTP
Multi Broadcast	IGMP Snooping IGMP v1/v2
Port Mirroring	Supports N:1 port mirroring
QoS	FIFO (First In First Out) SP (Strict Priority) WRR (Weighted Round Robin)
MAC Address Management	MAC address auto-aging Supports setting static MAC address
Loading and Upgrade	Supports upgrading by using HTTP Supports exporting/importing config file
Management and Maintenance	Supports SNMP v1/v2 and Web Manager.

FAQs

Q1: I cannot log in to the Web Manager when I used the device for the first time. What should I do?

A1: Perform the following, and retry.

- a) Make sure the IP address of local PC is 192.168.0.X (X can be any number of 2-254).
- b) Clean the browsing history of your Web browser; or try another browser and make sure the browser connection way is “Never dial a connection”.
- c) If you log in to the device from a PC, try updating your network adapter driver.
- d) If you still cannot log in to the device after try above operations, reset the device to factory default settings.

Q2: I forgot my login username and password unfortunately. What should I do?

A2: Try the default login info first. (Default LAN IP: **192.168.0.1**, Login username: **admin**; password: **admin**) If it does not work, reset the device to factory defaults and retry with the default settings.

Q3: How to reset the device when I cannot log in to the Web management?

A3: Press the Reset button for about 6 seconds and then release; in 20 seconds, the switch will be successfully reset to factory default settings. (Note: Resetting factory defaults will delete all the configured settings. You need to reconfigure them.)

Q4: The Link/Act LEDs lighted error, and I cannot figure out the device working status. What should I do?

A4: a) The switch and the remote device may be connected improperly. Try to verify their connections.
b) Try to reduce the cable usage as Ethernet cable may be over than the standard length (100Mbps: Cat 5e Ethernet \leq 150m; Extend mode and 10Mbps: Cat 5e Ethernet \leq 250m).

Q5: The PoE status LEDs lighted error, and I cannot figure out the device PoE working status. What should I do?

A5: a) The switch and the remote device may be connected improperly. Try to verify their connections.
b) Ethernet cable may be over than the standard length (100Mbps: Cat 5e Ethernet \leq 150m; Extend mode and 10Mbps: Cat 5e Ethernet \leq 250m). Try to reduce the cable usage.
c) Log in to the device Web Manager, and check the port PoE feature is enabled.
d) Check PoE MAX LED status. If it lights, disconnect the PD to make sure the PoE MAX LED is off.

HIKVISION



Network Switch

Quick User Guide

This manual is applicable for the following products:

DS-3EXXXXP-E and DS-3DXXXP series network switch.

Safety Instruction:

You must carefully read this manual before use and installation of the product and keep this manual properly.



Warnings:

- Proper configuration of all passwords and other security settings is the responsibility of the installer and/or end-user.
- In the use of the product, you must be in strict compliance with the electrical safety regulations of the nation and region. Please refer to technical specifications for detailed information.
- Input voltage should meet both the SELV (Safety Extra Low Voltage) and the Limited Power Source with 100 to 240 VAC or 12 VDC according to the IEC60950-1 standard. Please refer to technical specifications for detailed information.
- Do not connect several devices to one power adapter as adapter overload may cause over-heating or a fire hazard.
- Please make sure that the plug is firmly connected to the power socket.
- If smoke, odor or noise rise from the device, turn off the power at once and unplug the power cable, and then please contact the service center.



Cautions

- Ensure unit is installed in a well-ventilated, dust-free environment.
- Unit is designed for indoor use only.
- Keep all liquids away from the device.
- Ensure environmental conditions meet factory specifications.
- Ensure unit is properly secured to a rack or shelf. Major shocks or jolts to the unit as a result of dropping it may cause damage to the sensitive electronics within the unit.
- Use the device in conjunction with an UPS if possible.
- Power down the unit before connecting and disconnecting accessories and peripherals.
- A factory recommended HDD should be used for this device.
- Improper use or replacement of the battery may result in hazard of explosion. Replace with the same or equivalent type only. Dispose of used batteries according to the instructions provided by the battery manufacturer.

Trademarks Acknowledgement

HIKVISION and other Hikvision's trademarks and logos are the properties of Hikvision in various jurisdictions. Other trademarks and logos mentioned below are the properties of their respective owners.

Legal Disclaimer

TO THE MAXIMUM EXTENT PERMITTED BY APPLICABLE LAW, THE PRODUCT DESCRIBED, WITH ITS HARDWARE, SOFTWARE AND FIRMWARE, IS PROVIDED "AS IS", WITH ALL FAULTS AND ERRORS, AND HIKVISION MAKES NO WARRANTIES, EXPRESS OR IMPLIED, INCLUDING WITHOUT LIMITATION, MERCHANTABILITY, SATISFACTORY QUALITY, FITNESS FOR A PARTICULAR PURPOSE, AND NON-INFRINGEMENT OF THIRD PARTY. IN NO EVENT WILL HIKVISION, ITS DIRECTORS, OFFICERS, EMPLOYEES, OR AGENTS BE LIABLE TO YOU FOR ANY SPECIAL, CONSEQUENTIAL, INCIDENTAL, OR INDIRECT DAMAGES, INCLUDING, AMONG OTHERS, DAMAGES FOR LOSS OF BUSINESS PROFITS, BUSINESS INTERRUPTION, OR LOSS OF DATA OR DOCUMENTATION, IN CONNECTION WITH THE USE OF THIS PRODUCT, EVEN IF HIKVISION HAS BEEN ADVISED OF THE POSSIBILITY OF SUCH DAMAGES.

REGARDING TO THE PRODUCT WITH INTERNET ACCESS, THE USE OF PRODUCT SHALL BE WHOLLY AT YOUR OWN RISKS. HIKVISION SHALL NOT TAKE ANY RESPONSIBILITIES FOR ABNORMAL OPERATION, PRIVACY LEAKAGE OR OTHER DAMAGES RESULTING FROM CYBER ATTACK, HACKER ATTACK, VIRUS INSPECTION, OR OTHER INTERNET SECURITY RISKS; HOWEVER, HIKVISION WILL PROVIDE TIMELY TECHNICAL SUPPORT IF REQUIRED.

SURVEILLANCE LAWS VARY BY JURISDICTION. PLEASE CHECK ALL RELEVANT LAWS IN YOUR JURISDICTION BEFORE USING THIS PRODUCT IN ORDER TO ENSURE THAT YOUR USE CONFORMS THE APPLICABLE LAW. HIKVISION SHALL NOT BE LIABLE IN THE EVENT THAT THIS PRODUCT IS USED WITH ILLEGITIMATE PURPOSES.

IN THE EVENT OF ANY CONFLICTS BETWEEN THIS MANUAL AND THE APPLICABLE LAW, THE LATER PREVAILS.



PRODUCED BY:

Hangzhou Hikvision Digital Technology Co. Ltd.
Qianmo Road 555, Binjiang District, Hangzhou
310052, China
Made in China

CONTACT INFORMATION:

Hangzhou Hikvision Digital Technology Co. Ltd.
Qianmo Road 555, Binjiang District, Hangzhou
310052, China
Tel: +86-571-8807-5998
Fax: +86-571-8993-5635

This document introduces the procedure of using the network switch.

Step 1. Connect the switch to remote devices with Ethernet cable via RJ45 port.

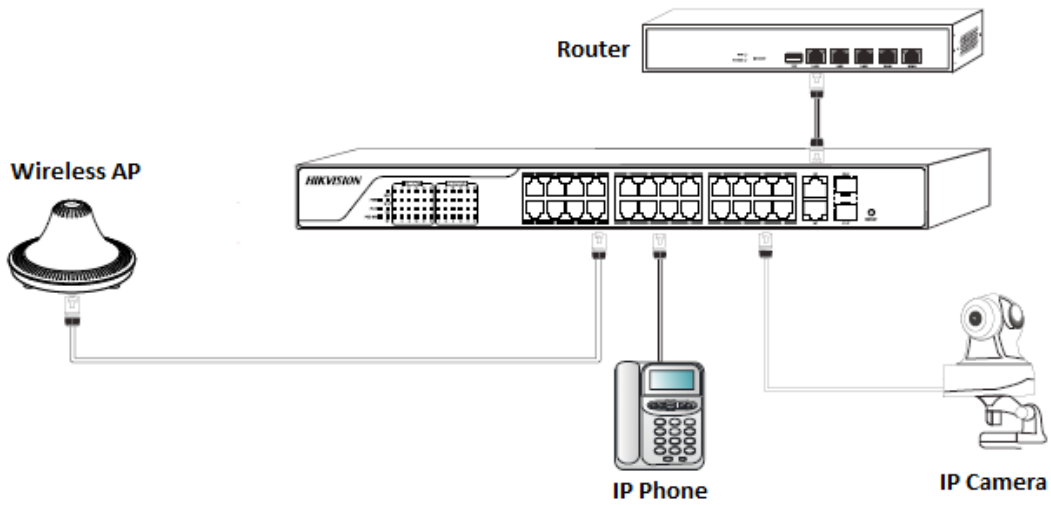

Step 2. For the models with SFP port, connect the optical module to the SFP port.

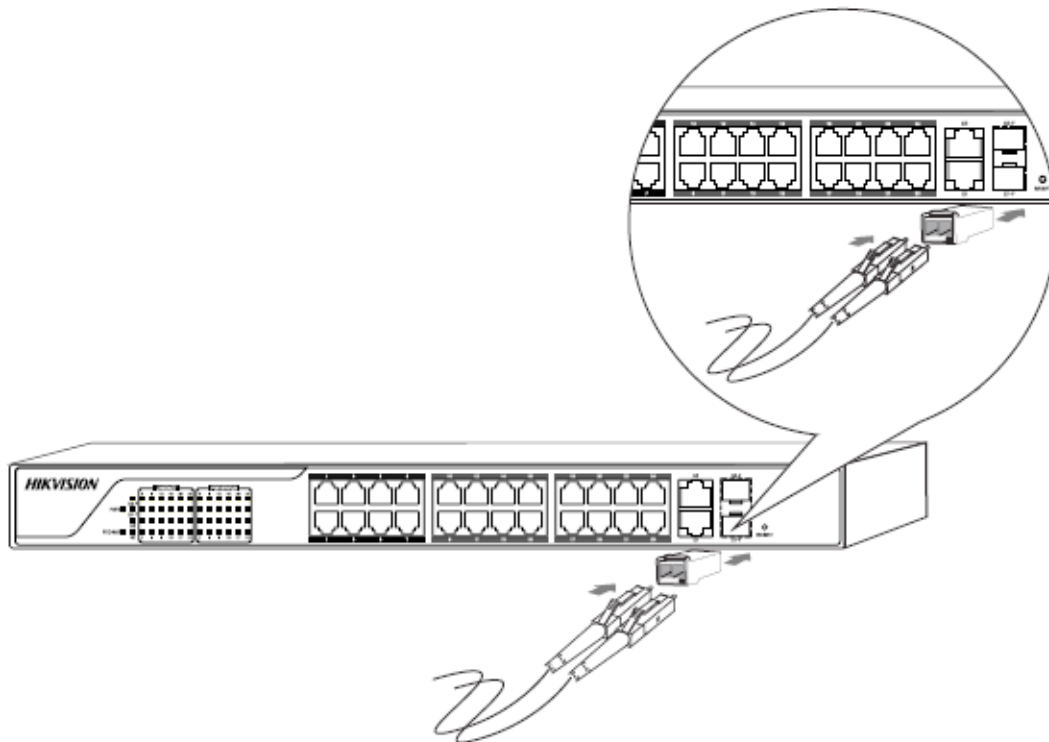

Step 3. Check the cabling of the device as following.

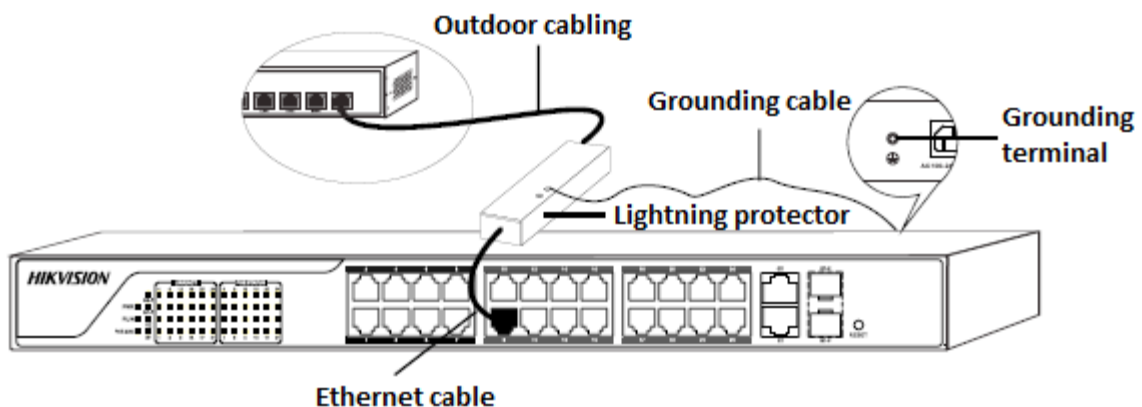

Step 4. Connect the switch to the power supply.

Step 5. Connect a PC to the switch via RJ45 port using an Ethernet cable.

Step 6. Configure the IP address of PC as 192.168.0.x (“x” can be any number in 2-254), and subnet mask as 255.255.255.0.

Step 7. Log in to the switch by typing the default IP address in the address bar and press Enter.

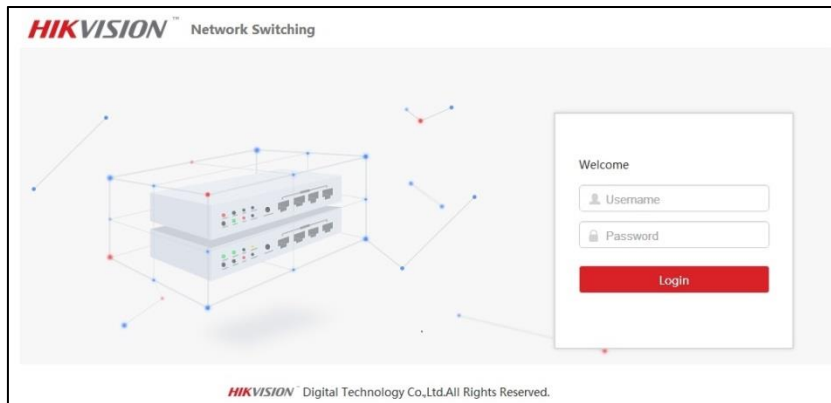

Step 8. Configure the switch parameters as needed.

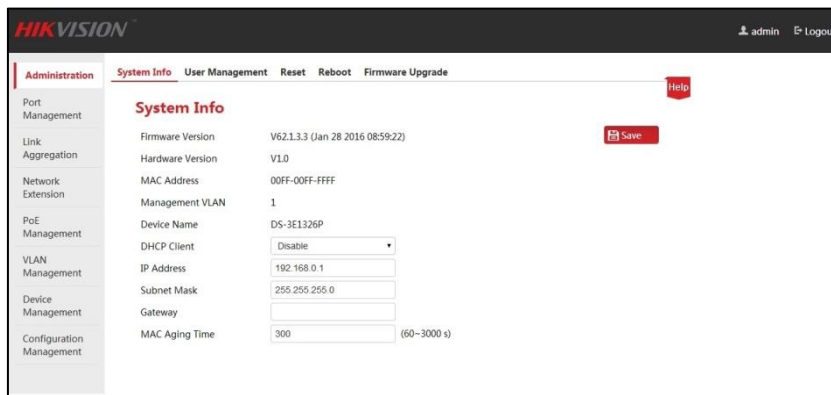

Note: For the detailed operation of network switch, refer to the user manual which can be downloaded from www.hikvision.com according to the specific model.

TECHNICAL SUPPORT

In case of any problem, please immediately contact the local after-sales service authorized by Hikvision.

Diese Anleitung gilt für folgende Produkte:

DS-3EXXXXP-E und DS-3DXXXP Netzwerk-Switch.

Sicherheitshinweis:

Lesen Sie vor der Benutzung und Installation der Kamera aufmerksam diese Anleitung und bewahren Sie sie sicher auf.



Warnhinweise:

- Für die korrekte Konfiguration aller Passwörter und aller sonstigen Einstellungen ist der Installateur und/oder Endbenutzer verantwortlich.
- Beachten Sie bei der Benutzung des Produkts unbedingt die geltenden Sicherheitsvorschriften für Elektrogeräte und -anlagen. Ausführliche Hinweise entnehmen Sie bitte den technischen Daten.
- Die Eingangsspannung muss sowohl die Anforderungen für Sicherheitskleinspannung (SELV) als auch die für Spannungsversorgungen mit begrenzter Leistung mit 100-240 VAC oder 12 VDC gemäß der Norm IEC60950-1 erfüllen. Ausführliche Hinweise entnehmen Sie bitte den technischen Daten.
- Schließen Sie nicht mehrere Geräte an einen Netzadapter an, weil eine Überlastung des Adapters zur Überhitzung und dadurch zur Brandgefahr führen kann.
- Achten Sie darauf, dass der Stecker korrekt an der Buchse angeschlossen ist.
- Sollte das Gerät Rauch, Geruch oder Geräusche abgeben, unterbrechen Sie sofort die Stromversorgung und wenden sich an den Kundendienst.



Vorsichtsmaßnahmen

- Achten Sie darauf, dass das Gerät in einer gut belüfteten, staubfreien Umgebung installiert ist.
- Das Gerät ist nur für den Betrieb im Innenbereich vorgesehen.
- Halten Sie das Gerät von Flüssigkeiten aller Art fern.
- Achten Sie darauf, dass die herstellereitig vorgegebenen Umgebungsbedingungen erfüllt werden.
- Achten Sie darauf, dass das Gerät sicher in einem Gestell oder Regal fixiert ist. Die empfindliche Elektronik im Gerät kann beschädigt werden, wenn das Gerät starken Erschütterungen oder Stößen (z. B. durch Fallenlassen) ausgesetzt wird.
- Benutzen Sie das Gerät möglichst in Verbindung mit einer unterbrechungsfreien Stromversorgung.
- Schalten Sie das Gerät aus, bevor Sie Zubehör- oder Peripheriekomponenten anschließen und abtrennen.
- Für dieses Gerät ist ein herstellereitig empfohlenes Festplattenlaufwerk (HDD) zu benutzen.
- Bei unsachgemäßer Benutzung oder Auswechslung der Batterie besteht Explosionsgefahr. Ersetzen Sie sie nur durch eine andere desselben oder eines entsprechenden Typs. Verbrauchte Batterien sind gemäß Herstelleranweisung zu entsorgen.

Warenzeichen

HIKVISION und andere Marken und Logos von Hikvision sind Eigentum von Hikvision in verschiedenen Ländern. Sonstige unten aufgeführte Marken und Logos sind Eigentum ihrer jeweiligen Inhaber.

Haftungsausschluss

DAS BESCHRIEBENE PRODUKT MITSAMT HARDWARE, SOFTWARE UND FIRMWARE WIRD IM GESETZLICH ZULÄSSIGEN RAHMEN OHNE MÄNGELGEWÄHR MIT SÄMTLICHEN FEHLERN UND PROBLEMEN ZUR VERFÜGUNG GESTELLT. HIKVISION GIBT KEINERLEI AUSDRÜCKLICHE ODER IMPLIZITE GARANTIE WIE ETWA ZUR MARKTGÄNGIGKEIT, ZUR QUALITÄT, ZUR EIGNUNG FÜR EINEN BESTIMMTEN ZWECK UND ZUR NICHTVERLETZUNG DER RECHTE DRITTER AB. IN KEINEM FALL HAFTEN HIKVISION, SEINE GESCHÄFTSFÜHRER, LEITENDEN ANGESTELLTEN, MITARBEITER ODER VERTRETER FÜR KONKRETE, MITTELBARE ODER UNMITTELBARE FOLGESCHÄDEN (EINSCHLIESSLICH SCHÄDEN DURCH ENTGANGENEM GEWINN, GESCHÄFTSUNTERBRECHUNG, VERLUST VON GESCHÄFTSINFORMATIONEN ODER FEHLENDE DOKUMENTATION), DIE AUFGRUND DER VERWENDUNG DIESES PRODUKTS ENTSTANDEN SIND, SELBST WENN HIKVISION AUF DIE MÖGLICHKEIT DERARTIGER SCHÄDEN HINGEWIESEN WURDE.

BEZÜGLICH DES PRODUKTS MIT INTERNETZUGANG ERFOLGT DIE BENUTZUNG DES PRODUKTS VOLLSTÄNDIG AUF IHR EIGENES RISIKO. HIKVISION ÜBERNIMMT KEINE VERANTWORTUNG FÜR UNGEWÖHNLICHEN BETRIEB, DIE VERÖFFENTLICHUNG PRIVATER DATEN ODER FÜR ANDERE SCHÄDEN AUFGRUND VON CYBER- UND HACKERANGRIFFEN, VIRENPRÜFUNGEN ODER ANDEREN INTERNETSICHERHEITSRISIKEN. BEI BEDARF STELLT HIKVISION JEDOCH RECHTZEITIG TECHNISCHEM SUPPORT BEREIT.

DIE REGELUNGEN ZUR ÜBERWACHUNG SIND VON LAND ZU LAND UNTERSCHIEDLICH. PRÜFEN SIE VOR DER VERWENDUNG DIESES PRODUKTS DIE VEREINBARKEIT MIT DEN JEWEILS GELTENDEN GESETZLICHEN REGELUNGEN. HIKVISION HAFTET NICHT FÜR DIE UNZULÄSSIGE NUTZUNG DIESES PRODUKTS.

EINZELNE ANWEISUNGEN IN DIESEM HANDBUCH, DIE NICHT MIT DEM GELTENDEN RECHT VEREINBAR SIND, SIND ZU IGNORIEREN.



HERGESTELLT VON:

Hangzhou Hikvision Digital Technology Co. Ltd.
Qianmo Road 555, Binjiang District, Hangzhou
310052, China
Made in China

KONTAKT:

Hangzhou Hikvision Digital Technology Co. Ltd.
Qianmo Road 555, Binjiang District, Hangzhou
310052, China
Tel.: +86-571-8807-5998
Fax: +86-571-8993-5635

Dieses Dokument enthält Hinweise zur Benutzung des Netzwerk-Switch.

Schritt 1 Schließen Sie den Switch mit einem Ethernet-Kabel über den RJ45-Port an externen Geräten an.

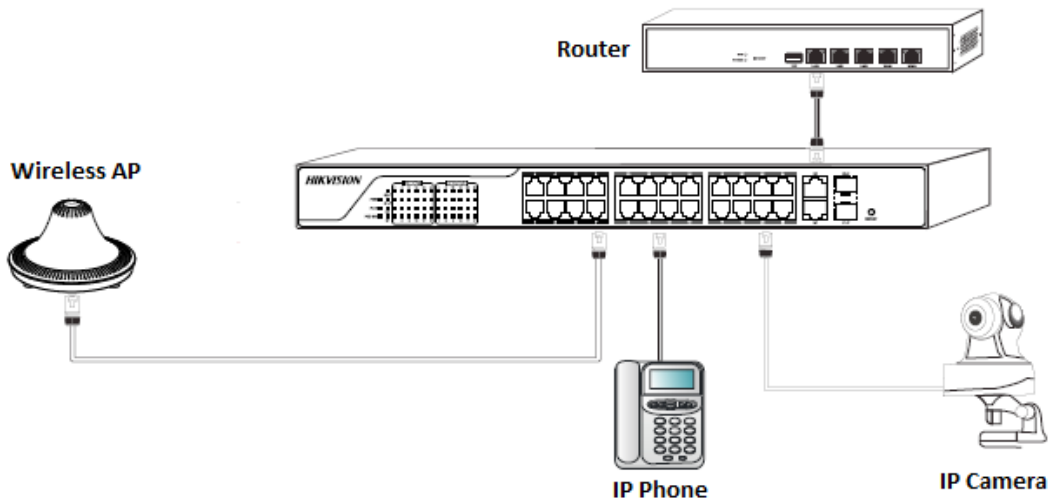

Schritt 2 Bei Modellen mit SFP-Port schließen Sie das optische Modul am SFP-Port an

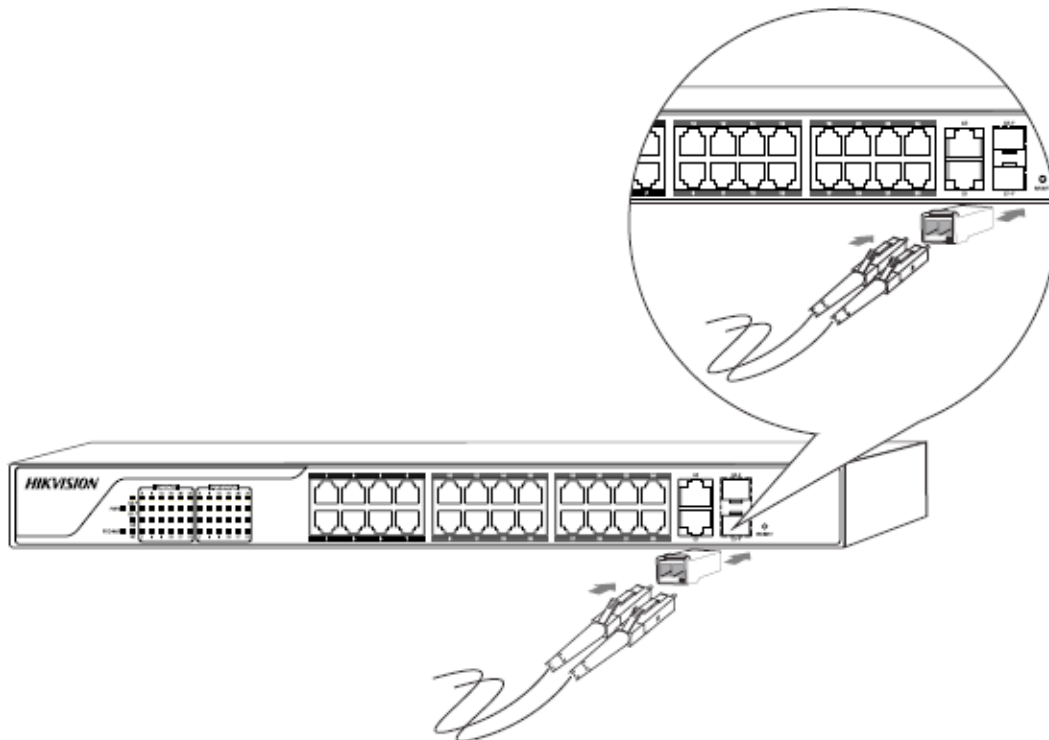

Schritt 3 Überprüfen Sie die Verkabelung des Geräts wie folgt.

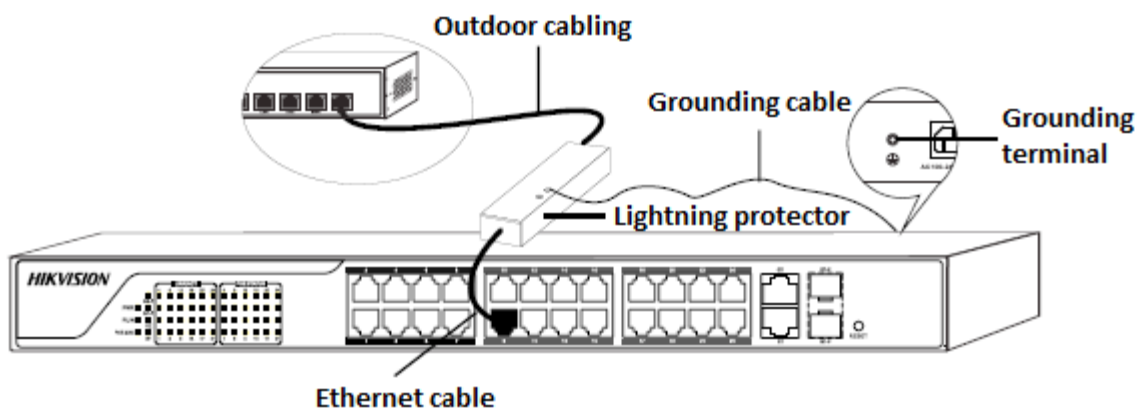

Schritt 4 Schließen Sie den Switch an der Spannungsversorgung an.

Schritt 5 Schließen Sie einen PC mit einem Ethernet-Kabel am RJ45-Port an.

Schritt 6 Konfigurieren Sie die IP-Adresse des PC als 192.168.0.x (wobei „x“ jede Zahl zwischen 2 und 254 sein kann) und die Subnetzmaske als 255.255.255.0.

Schritt 7 Melden Sie den Switch an, indem Sie die standardmäßige IP-Adresse in die Adresszeile eingeben und dann die Eingabetaste betätigen.

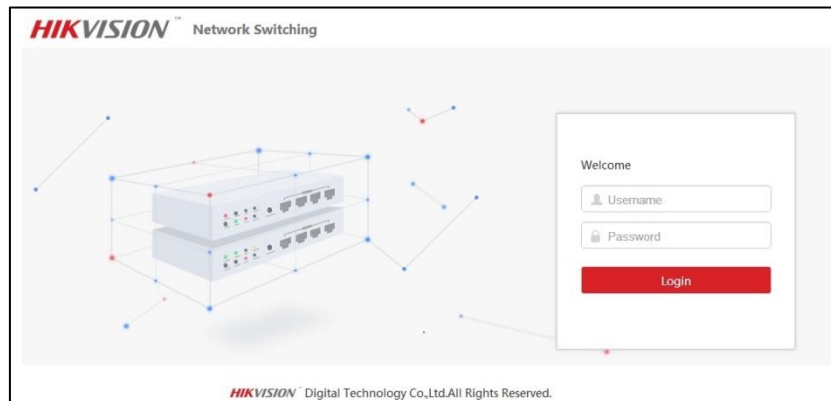

Schritt 8 Konfigurieren Sie die Switch-Parameter je nach Bedarf.

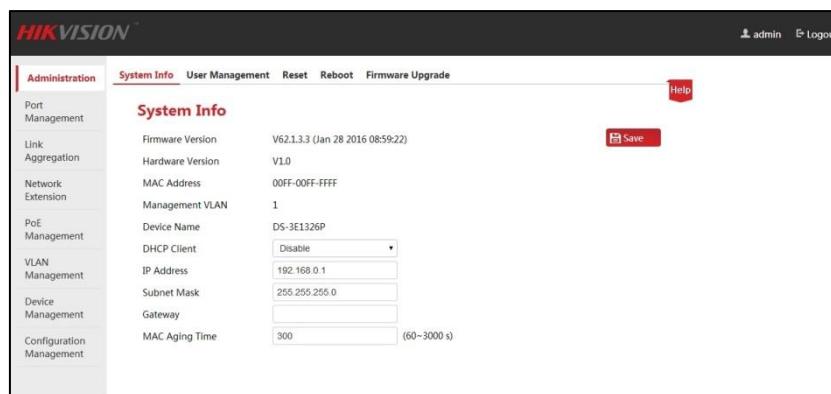

Hinweis: Einzelheiten zum Betrieb des Netzwerk-Switch finden Sie im Benutzerhandbuch zum jeweiligen Modell, das Sie von www.hikvision.com herunterladen können.

TECHNISCHE UNTERSTÜTZUNG

Bei Problemen wenden Sie sich bitte unverzüglich an einen von Hikvision autorisierten Kundendienstbetrieb vor Ort.

Este manual se aplica a los siguientes productos:

Conmutador de redde las series DS-3EXXXXP-E y DS-3DXXXP.

Instrucciones de seguridad:

Debe leer este manual con atención antes de utilizar e instalar el producto y guardarlo adecuadamente.

**Advertencias:**

- La correcta configuración de todas las contraseñas y otros parámetros de seguridad es responsabilidad del instalador o el usuario final.
- Mientras utilice el producto, debe respetar estrictamente los reglamentos nacionales y regionales de seguridad eléctrica. Compruebe las especificaciones técnicas para obtener más información.
- La tensión de entrada deberá cumplir con las normas de tensión de entrada de seguridad extra-baja (SELV, por sus siglas en inglés) y con el requisito de fuente de alimentación limitada de 100 a 240 V CA o 12 V DC, de acuerdo con la normativa IEC60950-1. Compruebe las especificaciones técnicas para obtener más información.
- No conecte varios dispositivos en un solo adaptador de corriente, ya que la sobrecarga del adaptador podría provocar sobrecalentamiento o riesgo de incendio.
- Asegúrese de que el enchufe esté bien conectado a la toma de corriente.
- Si sale humo, olor o ruido del dispositivo, apáguelo de inmediato y desenchufe el cable de alimentación. A continuación, póngase en contacto con el servicio técnico.

**Precauciones:**

- Asegúrese de que la unidad esté instalada en un entorno bien ventilado y sin polvo.
- La unidad está diseñada para uso exclusivo en interior.
- Mantenga todo tipo de líquidos alejados del dispositivo.
- Asegúrese de que las condiciones ambientales cumplan las especificaciones de fábrica.
- Asegúrese de que la unidad esté bien sujeta a un bastidor o una estantería. Las sacudidas o golpes fuertes en la unidad como resultado de una caída podrían dañar la electrónica sensible del interior.
- Utilice el dispositivo conectado a un SAI si es posible.
- Apague la unidad antes de conectar y desconectar accesorios y periféricos.
- Se debe utilizar una unidad de disco duro (HDD) recomendada por el fabricante para este dispositivo.
- El uso inadecuado o la sustitución de la batería podrían provocar riesgo de explosión. Sustituya el equipo exclusivamente por otro de tipo similar o equivalente. Deseche las pilas usadas de acuerdo a las instrucciones facilitadas por el fabricante de las mismas.

Reconocimiento de marcas comerciales

HIKVISION y otras marcas comerciales y logotipos de Hikvision pertenecen a Hikvision en varias jurisdicciones. Otras marcas comerciales y logotipos mencionados a continuación son propiedad de sus respectivos dueños.

Aviso legal

AL MÁXIMO EFECTO PERMITIDO POR LA LEGISLACIÓN VIGENTE, EL PRODUCTO DESCRITO, JUNTO CON SU HARDWARE, SOFTWARE Y FIRMWARE, SE PROPORCIONA "TAL CUAL", CON TODOS SUS DEFECTOS Y ERRORES. HIKVISION NO OFRECE GARANTÍAS, NI EXPRESAS NI IMPLÍCITAS, INCLUYENDO SIN LIMITACIÓN, LA COMERCIALIZACIÓN, LA CALIDAD SATISFACTORIA, LA APTITUD PARA UN FIN PARTICULAR Y EL NO CUMPLIMIENTO DE TERCERAS PARTES. HIKVISION, SUS DIRECTORES, RESPONSABLES, EMPLEADOS O AGENTES NO SERÁN RESPONSABLES EN NINGÚN CASO ANTE USTED POR DAÑOS DERIVADOS, INCIDENTALES O INDIRECTOS (INCLUIDOS LOS DAÑOS POR LUCRO CESANTE, INTERRUPTIÓN DEL NEGOCIO, PÉRDIDA DE INFORMACIÓN Y DOCUMENTACIÓN) QUE SE DERIVEN DEL USO DE ESTE PRODUCTO, AUNQUE SE HAYA ADVERTIDO A HIKVISION DE LA POSIBILIDAD DE TALES DAÑOS.

EN LO RELATIVO AL PRODUCTO CON ACCESO A INTERNET, EL USO DE TAL PRODUCTO SE HARÁ TOTALMENTE BAJO SU PROPIA CUENTA Y RIESGO. HIKVISION NO SE HARÁ RESPONSABLE DE FUNCIONAMIENTOS ANÓMALOS, FALLOS DE PRIVACIDAD U OTROS DAÑOS RESULTANTES DE CIBERATAQUES, ATAQUES DE PIRATAS INFORMÁTICOS, INSPECCIÓN DE VIRUS U OTROS RIESGOS DE SEGURIDAD EN INTERNET. NO OBSTANTE, HIKVISION PROPORCIONARÁ UN SOPORTE TÉCNICO RÁPIDO SI FUESE NECESARIO.

LAS LEYES DE VIGILANCIA PUEDEN VARIAR DEPENDIENDO DE LA JURISDICCIÓN. COMPRUEBE TODAS LAS LEYES PERTINENTES DE SU JURISDICCIÓN ANTES DE USAR ESTE PRODUCTO PARA ASEGURARSE DE QUE SU USO SE REALICE DE CONFORMIDAD CON LA LEGISLACIÓN VIGENTE. HIKVISION NO SERÁ RESPONSABLE EN CASO DE QUE ESTE PRODUCTO SE USE CON PROPÓSITOS ILEGALES.

EN CASO DE CUALQUIER CONFLICTO ENTRE ESTE MANUAL Y LA LEGISLACIÓN VIGENTE, TENDRÁ PRIORIDAD ESTA ÚLTIMA.



PRODUCIDO POR:

Hangzhou Hikvision Digital Technology Co. Ltd.
Qianmo Road 555, Binjiang District, Hangzhou
310052, China
Fabricado en China

IMPORTADO A EU POR

Hikvision Spain
Almazara 9
28760 Tres Cantos (Madrid)
Spain
Tel: +34 91 737 16 55
Email: info.es@hikvision.com

Este documento presenta el procedimiento para usar el conmutador de red.

Paso 1 Conecte el conmutador a dispositivos remotos con un cable Ethernet a través del puerto RJ45.

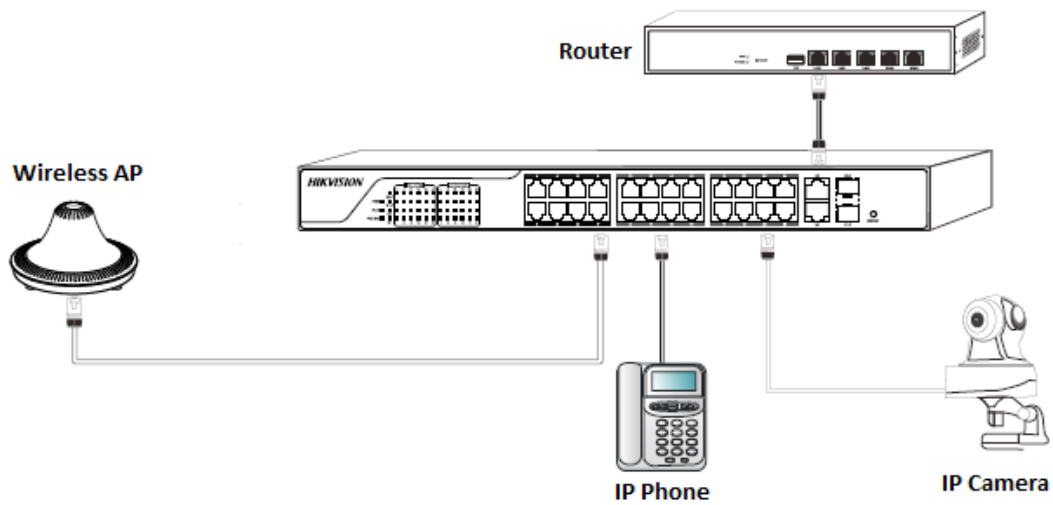

Paso 2 En el caso de los modelos con puerto SFP, conecte el módulo óptico al puerto SFP.

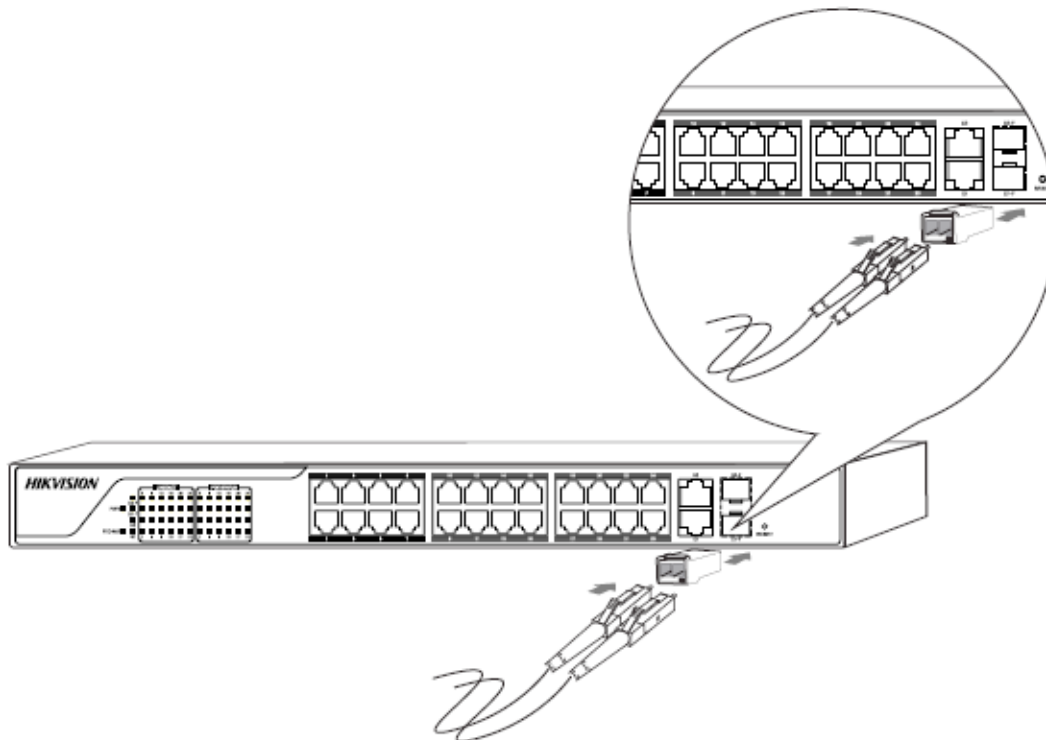

Paso 3 Compruebe el cableado del dispositivo como se indica a continuación.

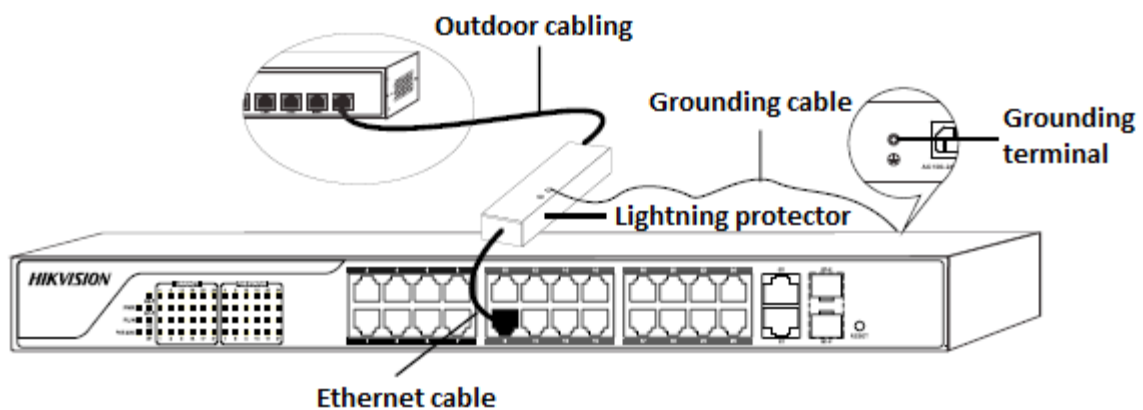

Paso 4 Conecte el conmutador a la fuente de alimentación.

Paso 5 Conecte un ordenador al conmutador a través del puerto RJ45 utilizando un cable Ethernet.

Paso 6 Configure la dirección IP del ordenador como 192.168.0.x ("x" puede ser cualquier número de 2 a 254) y la máscara de subred como 255.255.255.0.

Paso 7 Inicie sesión en el conmutador escribiendo la dirección IP predeterminada en la barra de direcciones y pulse Intro.

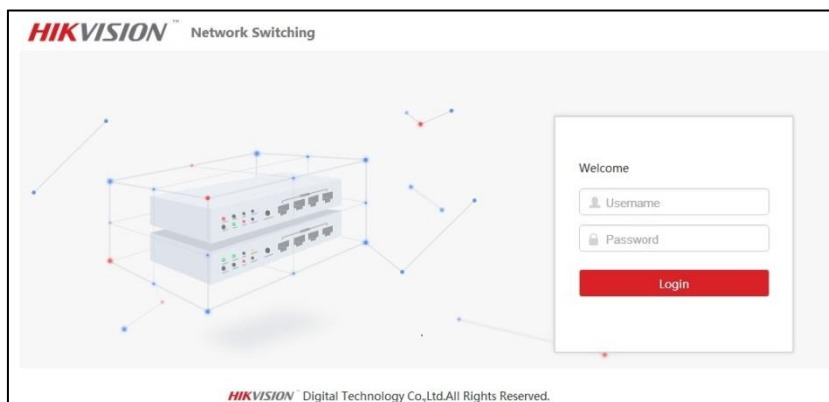

Paso 8 Configure los parámetros del conmutador según proceda.

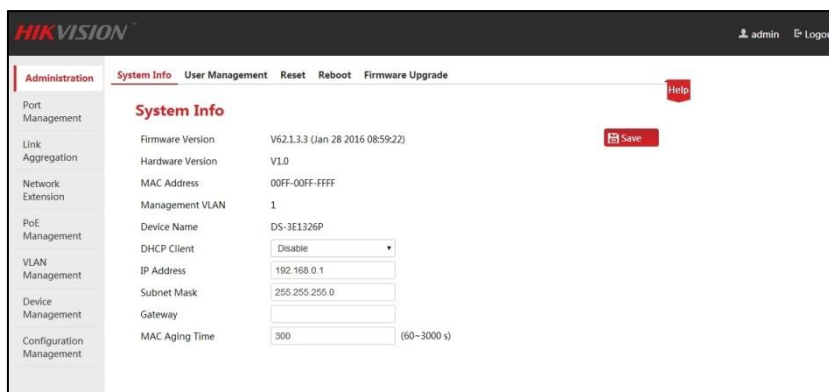

Nota: Para ver el funcionamiento detallado del conmutador de red, consulte el manual de usuario que podrá descargar en www.hikvision.com según el modelo concreto.

ASISTENCIA TÉCNICA

Si experimenta algún problema, póngase en contacto de inmediato con el servicio posventa local autorizado por Hikvision.

Le présent manuel s'applique aux produits suivants :

Commutateur réseau séries DS-3EXXXXP-E et DS-3DXXXP.

Consignes de sécurité :

Lisez attentivement ce manuel avant d'installer et d'utiliser ce produit, et rangez-le en lieu sûr.



Avertissements :

- La configuration de tous les mots de passe et des autres paramètres de sécurité relève de la responsabilité de l'installateur et/ou de l'utilisateur final.
- Lors de l'utilisation du produit, vous devez respecter scrupuleusement les réglementations de sécurité électrique nationales et régionales en vigueur. Pour plus de précisions, reportez-vous aux spécifications techniques.
- La tension d'entrée doit répondre à la fois aux spécifications SELV (Safety Extra Low Voltage) et LPS (Limited Power Source), de 100 à 240 VCA ou de 12 VCC, conformément à la norme IEC60950-1. Pour plus de précisions, reportez-vous aux spécifications techniques.
- Ne branchez pas plusieurs appareils sur un même adaptateur, toute surcharge de l'adaptateur pouvant entraîner sa surchauffe ou provoquer un incendie.
- Assurez-vous que la prise est correctement raccordée au secteur.
- Si l'appareil dégage de la fumée ou une odeur suspecte, ou s'il émet des bruits inhabituels, éteignez-le et débranchez le câble d'alimentation, puis contactez le SAV.



Précautions

- Assurez-vous que l'unité est installée dans un endroit bien ventilé et exempt de poussière.
- Cette unité est conçue pour être utilisée à l'intérieur.
- Évitez toute présence de liquides à proximité de l'appareil.
- Assurez-vous que les conditions environnementales sont conformes aux spécifications du fabricant.
- Assurez-vous que l'unité est correctement installée dans un châssis ou sur une étagère. En cas de chocs importants ou de secousses, les composants électroniques sensibles de l'appareil peuvent être endommagés.
- Dans la mesure du possible, utilisez l'appareil avec une alimentation sans interruption (onduleur).
- Éteignez l'appareil avant de brancher ou de débrancher des accessoires et des périphériques.
- Utilisez un disque dur recommandé par le fabricant.
- Une mauvaise utilisation de la batterie ou un remplacement par une batterie incompatible peut entraîner un risque d'explosion. Ne la remplacez que par une batterie identique ou de type équivalent. Mettez les batteries usagées au rebut conformément aux instructions du fabricant.

Reconnaissance des marques commerciales

HIKVISION et les autres marques commerciales et logos de Hikvision sont la propriété de Hikvision dans différentes juridictions. Les autres marques commerciales et logos mentionnés ci-après sont la propriété de leurs détenteurs respectifs.

Décharge de responsabilité juridique

DANS LES LIMITES AUTORISÉES PAR LA LOI EN VIGUEUR, LE PRODUIT DÉCRIT, AVEC SES ÉLÉMENTS MATÉRIELS ET LOGICIELS, ET SES MICROPROGRAMMES, EST FOURNI "EN L'ÉTAT", AVEC TOUS LES DÉFAUTS ET ERREURS POTENTIELS. HIKVISION DÉCLINE TOUTE GARANTIE, EXPRESSE OU IMPLICITE, NOTAMMENT EN TERMES DE QUALITÉ MARCHANDE, D'ADÉQUATION À UN USAGE SPÉCIFIQUE ET DE NON-INFRACTION À D'ÉVENTUELS DROITS DE TIERS. HIKVISION, SES DIRIGEANTS, SES CADRES, SES EMPLOYÉS OU SES AGENTS NE PEUVENT EN AUCUN CAS ÊTRE TENUS POUR RESPONSABLES DES PRÉJUDICES SPÉCIAUX, INDUITS OU INDIRECTS, Y COMPRIS, ENTRE AUTRES, LE MANQUE À GAGNER, LES INTERRUPTIONS D'ACTIVITÉ OU LA PERTE DE DONNÉES OU DE DOCUMENTATION DÉCOULANT DE L'UTILISATION DE CE PRODUIT, MÊME SI HIKVISION EST INFORMÉE DE L'ÉVENTUALITÉ DE TELS PRÉJUDICES.

CONCERNANT LE PRODUIT DOTÉ D'UN ACCÈS À INTERNET, SON UTILISATION S'EFFECTUE SOUS VOTRE ENTIÈRE RESPONSABILITÉ. HIKVISION DÉCLINE TOUTE RESPONSABILITÉ EN CAS D'ANOMALIE DE FONCTIONNEMENT, DE VIOLATION DE LA CONFIDENTIALITÉ OU DE TOUT AUTRE PRÉJUDICE RÉSULTANT D'UNE CYBERATTAQUE, D'UN ACTE DE PIRATERIE INFORMATIQUE, D'UN VIRUS OU DE TOUT AUTRE RISQUE POUR LA SÉCURITÉ SUR INTERNET. HIKVISION S'ENGAGE TOUTEFOIS À ASSURER UNE ASSISTANCE TECHNIQUE EN TEMPS OPPORTUN SI NÉCESSAIRE.

LA LÉGISLATION RELATIVE À LA SURVEILLANCE VARIE D'UNE JURIDICTION À L'AUTRE. AVANT D'UTILISER CE PRODUIT, ASSUREZ-VOUS DE SA CONFORMITÉ À LA LÉGISLATION EN VIGUEUR DANS VOTRE JURIDICTION. HIKVISION NE SAURAIT ÊTRE TENUE RESPONSABLE D'UNE UTILISATION DE CE PRODUIT À DES FINS ILLICITES.

DANS L'ÉVENTUALITÉ D'UN CONFLIT ENTRE LE PRÉSENT MANUEL ET LA LOI EN VIGUEUR, CETTE DERNIÈRE PRÉVAUT.



PRODUIT PAR :

Hangzhou Hikvision Digital Technology Co. Ltd.
Qianmo Road 555, Binjiang District, Hangzhou
310052, China
Fabriqué en Chine

CONTACT :

Hangzhou Hikvision Digital Technology Co. Ltd.
Qianmo Road 555, Binjiang District, Hangzhou
310052, China
Téléphone : +86-571-8807-5998
Télécopie : +86-571-8993-5635

Ce document présente la procédure d'utilisation du commutateur réseau.

Étape 1 Raccordez-le aux terminaux distants au moyen d'un câble Ethernet branché sur le port RJ45.

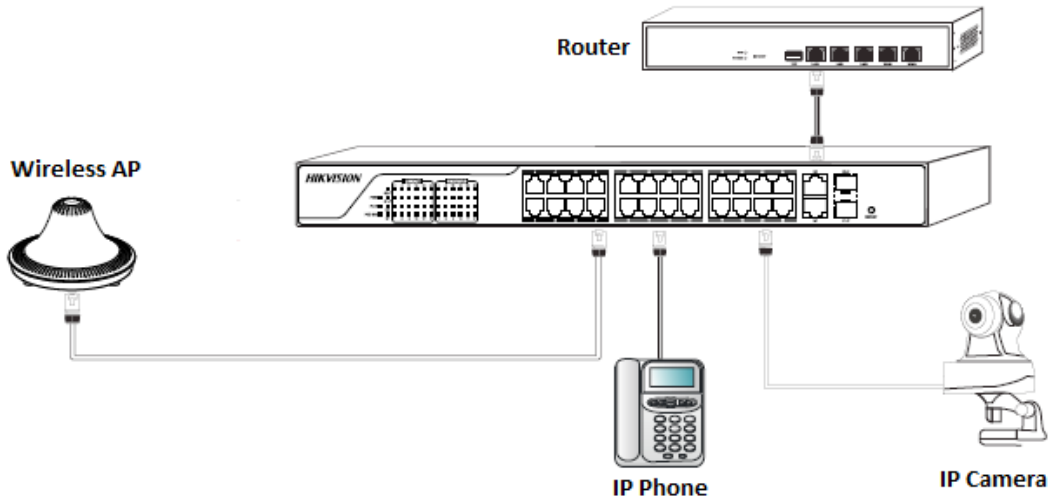

Étape 2 Concernant les modèles équipés d'un port SFP, connectez le module optique à celui-ci.

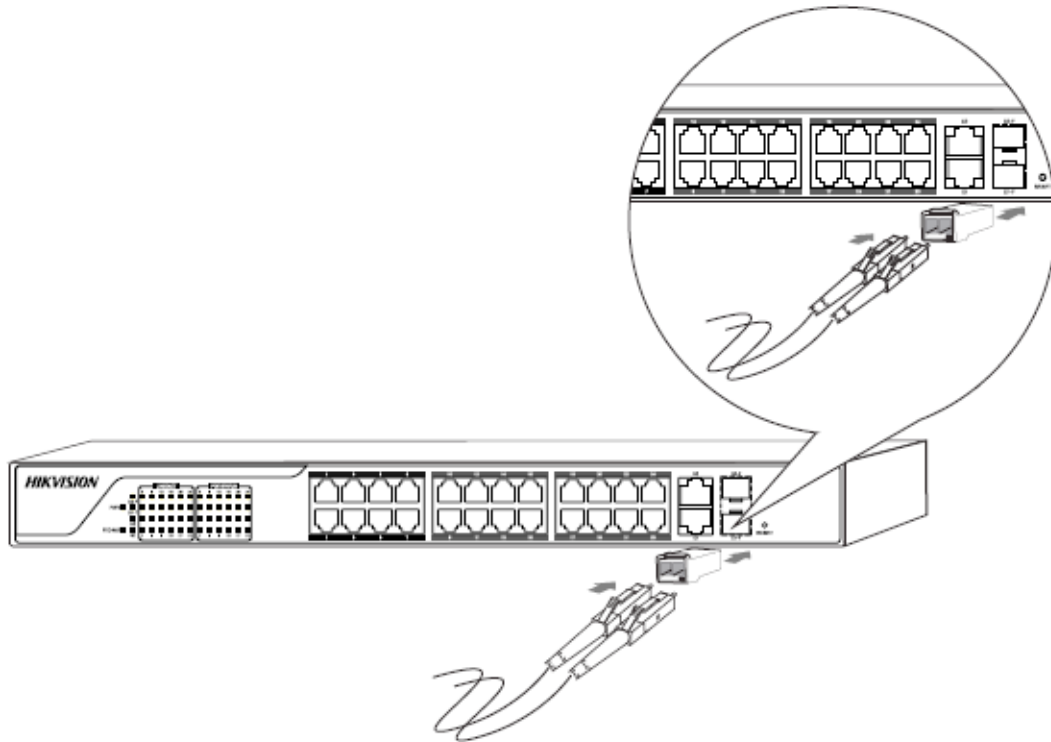

Étape 3 Contrôlez le câblage de l'appareil comme suit.

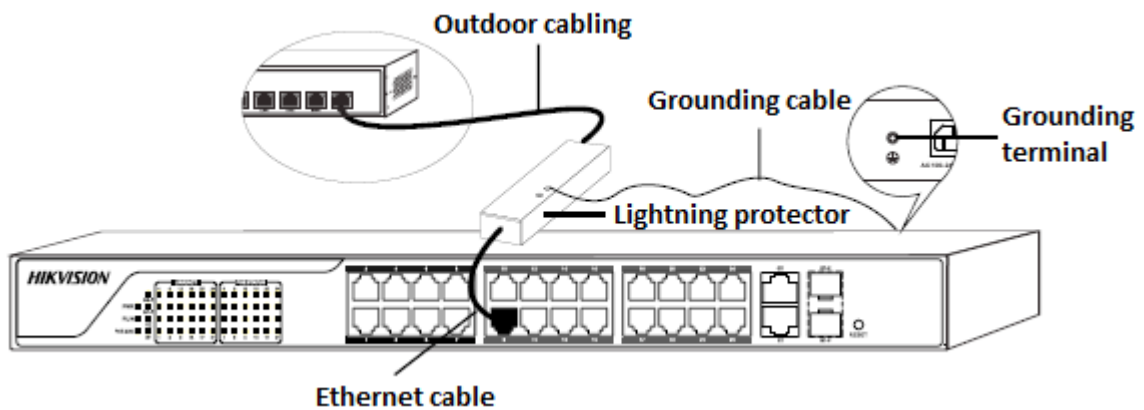

Étape 4 Branchez le commutateur à la prise de courant.

Étape 5 Branchez un PC au commutateur via le port RJ45 et un câble Ethernet.

Étape 6 Attribuez au PC l'adresse IP 192.168.0.x ("x" étant compris entre 2-254) et le masque de sous-réseau 255.255.255.0.

Étape 7 Connectez-vous au commutateur en tapant l'adresse IP par défaut dans la barre d'adresses puis appuyez sur Entrée.

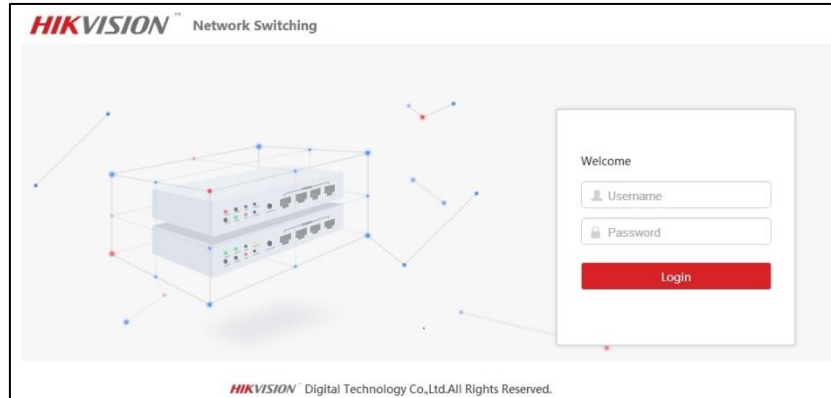

Étape 8 Configurez les paramètres du commutateur selon vos besoins.

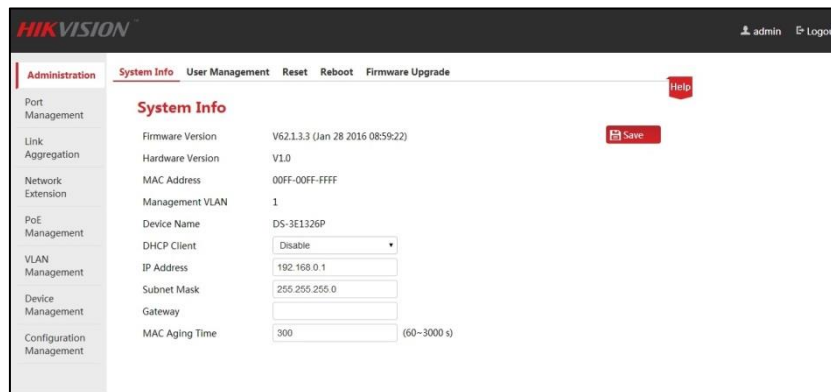

Remarque : Pour plus de précisions sur le fonctionnement du commutateur réseau, reportez-vous au manuel de l'utilisateur qui peut être téléchargé sur www.hikvision.com, où vous choisirez celui qui correspond à votre modèle.

ASSISTANCE TECHNIQUE

En cas de problème, contactez immédiatement le SAV local agréé Hikvision.

Il presente manuale si applica ai seguenti prodotti:

Switch di rete Serie DS-3EXXXXP-E e DS-3DXXXP.

per maggiori informazioni, prego visitare il sito <http://overseas.hikvision.com/europe/>

Istruzioni di sicurezza:

Leggere attentamente il presente manuale prima di utilizzare e installare il prodotto, e conservarlo correttamente.



Avvertenze:

- La corretta configurazione di tutte le password e di qualsiasi impostazione di sicurezza è responsabilità dell'installatore e/o dell'utente finale.
- Nell'uso del prodotto, è necessario rispettare rigorosamente la conformità alle norme di sicurezza elettrica vigenti. Per maggiori informazioni, fare riferimento alle specifiche tecniche.
- La tensione in ingresso deve soddisfare i requisiti SELV (Safety Extra Low Voltage) e i requisiti per le fonti di alimentazione limitate a 100 ~ 240 V CA o 12 V CC secondo lo standard IEC60950-1. Per maggiori informazioni, fare riferimento alle specifiche tecniche.
- Non collegare più dispositivi allo stesso alimentatore, per evitare di sovraccaricarlo e causare un surriscaldamento o il rischio di incendio.
- Accertarsi che la spina sia saldamente collegata alla presa di alimentazione.
- Se il dispositivo emette fumo, odore o rumore anomalo, interrompere immediatamente l'alimentazione e scollegare il cavo di alimentazione, poi contattare il centro assistenza.



Avvisi di cautela

- Verificare che l'unità sia installata in un ambiente ben ventilato e privo di polvere.
- L'unità è progettata esclusivamente per installazioni in ambienti interni.
- Tenere i liquidi lontano dal dispositivo.
- Accertarsi che le condizioni ambientali soddisfino le specifiche definite in fabbrica.
- Assicurare l'unità sia correttamente fissata a un rack o un ripiano. Urti o colpi a seguito di una caduta possono causare danni all'elettronica sensibile all'interno dell'unità.
- Se possibile, utilizzare il dispositivo in combinazione con un UPS.
- Spegnerne l'unità prima di collegare e scollegare accessori e periferiche.
- Per questo dispositivo è necessario utilizzare un HDD tra i modelli consigliati.
- La sostituzione o l'uso improprio della batteria possono esporre al pericolo di esplosione. Sostituire solo con batterie identiche o equivalenti. Smaltire le batterie usate secondo le istruzioni del produttore.

Marchi

HIKVISION e gli altri marchi e loghi Hikvision sono di proprietà di Hikvision in varie giurisdizioni. Gli altri marchi e loghi citati in questo manuale sono di proprietà dei rispettivi proprietari.

Declinazione di responsabilità

ENTRO I LIMITI PREVISTI DALLE LEGGI IN VIGORE, IL PRODOTTO DESCRITTO, COMPLETO DI HARDWARE, SOFTWARE E FIRMWARE, VIENE FORNITO "COSÌ COM'È", COMPRESI TUTTI I DIFETTI E GLI ERRORI, E HIKVISION NON FORNISCE ALCUNA GARANZIA, ESPLICITA O IMPLICITA, INCLUSE, SENZA LIMITAZIONE, GARANZIE DI COMMERCIALIZZABILITÀ, DI QUALITÀ SODDISFACENTE, DI IDONEITÀ PER UNO SCOPO PARTICOLARE E DI NON VIOLAZIONE DI DIRITTI DI TERZI. IN NESSUN CASO HIKVISION, I SUOI DIRIGENTI, FUNZIONARI, DIPENDENTI, O AGENTI SARANNO RESPONSABILI PER EVENTUALI DANNI SPECIALI, CONSEGUENZIALI, INCIDENTALI O INDIRETTI, COMPRESI, TRA GLI ALTRI, DANNI PER PERDITA DI PROFITTI, INTERRUZIONE DELL'ATTIVITÀ O PERDITA DI DATI O DI DOCUMENTAZIONE, CONNESSI ALL'USO DI QUESTO PRODOTTO, ANCHE QUALORA HIKVISION SIA STATA INFORMATO DELLA POSSIBILITÀ DEL VERIFICARSI DI TALI DANNI.

L'UTENTE SI ASSUME INTERAMENTE OGNI RISCHIO CORRELATO DALL'UTILIZZO DEL PRODOTTO CON ACCESSO INTERNET. HIKVISION DECLINA OGNI RESPONSABILITÀ PER ANOMALIE DI FUNZIONAMENTO, PERDITA DI PRIVACY O ALTRI DANNI DERIVANTI DA UN ATTACCO CIBERNETICO, ATTACCO DA PARTE DI HACKER, VIRUS O ALTRI RISCHI E MINACCE ALLA SICUREZZA, CORRELATI ALL'UTILIZZO DI INTERNET; TUTTAVIA, HIKVISION FORNIRÀ SUPPORTO TECNICO TEMPESTIVO, SE NECESSARIO.

LE LEGGI SULLA SORVEGLIANZA VARIANO DA GIURISDIZIONE A GIURISDIZIONE. SI PREGA DI CONTROLLARE TUTTE LE LEGGI PERTINENTI, VIGENTI NELLA PROPRIA GIURISDIZIONE, PRIMA DI UTILIZZARE QUESTO PRODOTTO, AL FINE DI GARANTIRE CHE L'UTILIZZO SIA CONFORME ALLE LEGGI VIGENTI. HIKVISION DECLINA OGNI RESPONSABILITÀ NEL CASO IN CUI QUESTO PRODOTTO VENGA UTILIZZATO PER SCOPI ILLECITI.

IN CASO DI EVENTUALI CONFLITTI TRA IL PRESENTE MANUALE E LA LEGGE APPLICABILE, PREVALE QUEST'ULTIMA.



PRODOTTO DA:

Hangzhou Hikvision Digital Technology Co. Ltd.
Qianmo Road 555, Binjiang District, Hangzhou
310052, Cina
Prodotto in Cina

IMPORTATO IN EU DA:

HIKVISION Italy S.r.l.
Via Abruzzo 12, ZI San Giacomo
31029 Vittorio Veneto (TV)
Italy
Tel: +39-0438-6902
Fax: +39-0438-690299
Email: info.it@hikvision.com

Il presente documento tratta la procedura di utilizzo dello switch di rete.

Punto 1 Collegare lo switch a dispositivi remoti tramite la porta RJ45 utilizzando un cavo Ethernet.

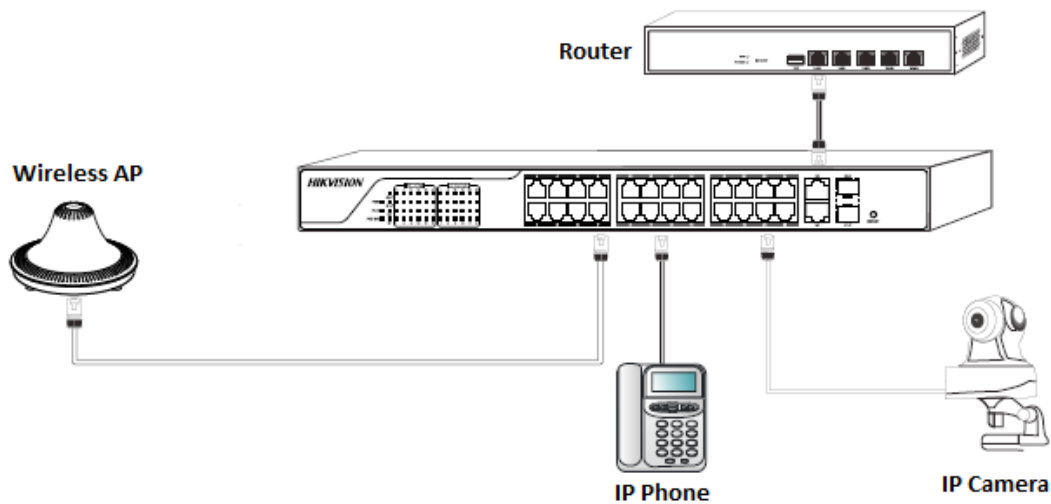

Punto 2 Per i modelli con porta SFP, collegare il modulo ottico alla porta SFP.

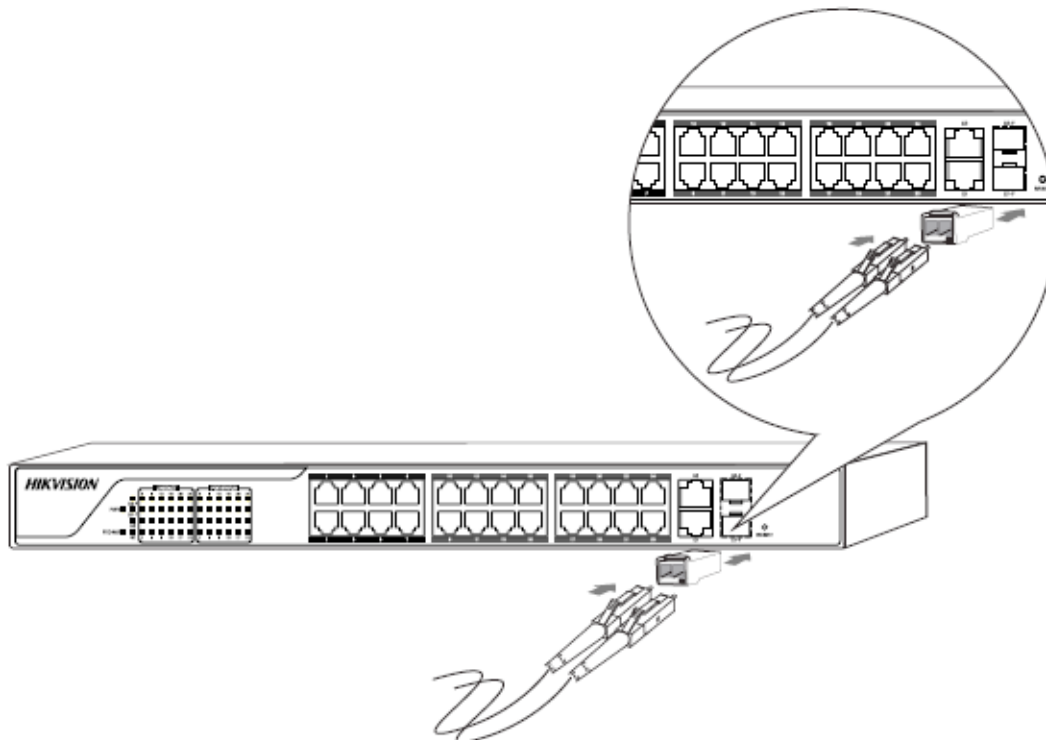

Punto 3 Verificare il cablaggio del dispositivo come segue.

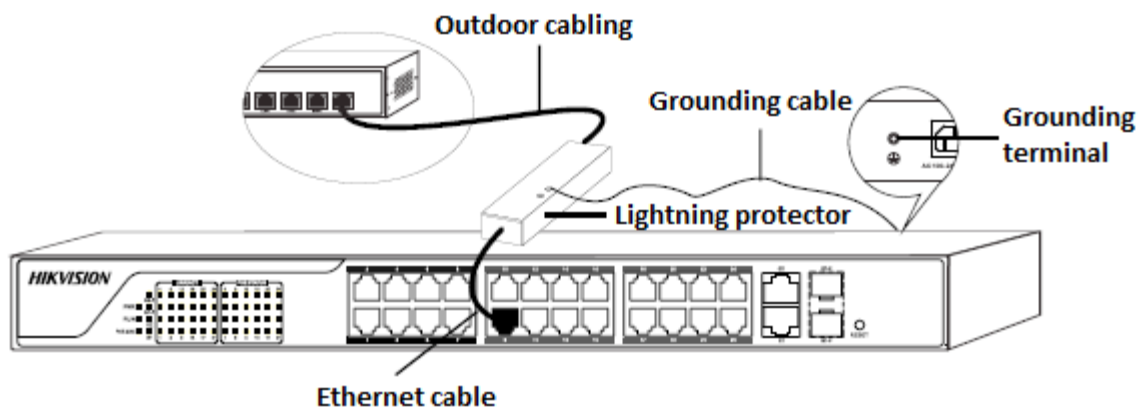

Punto 4 Collegare lo switch all'alimentazione.

Punto 5 Collegare un PC allo switch tramite la porta RJ45 utilizzando un cavo Ethernet.

Punto 6 Impostare l'indirizzo IP del PC su 192.168.0.x ("x" può essere qualsiasi numero compreso tra 2-254), e la subnet mask su 255.255.255.0.

Punto 7 Accedere allo switch digitando l'indirizzo IP predefinito nella barra degli indirizzi e premere Invio.

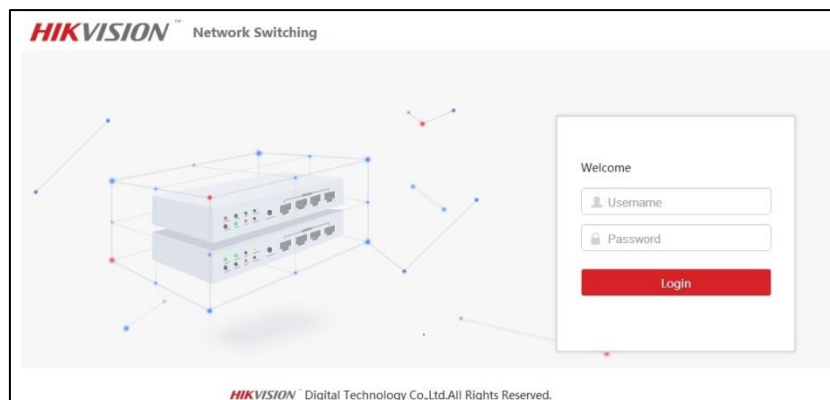

Punto 8 Configurare i parametri dello switch come necessario.

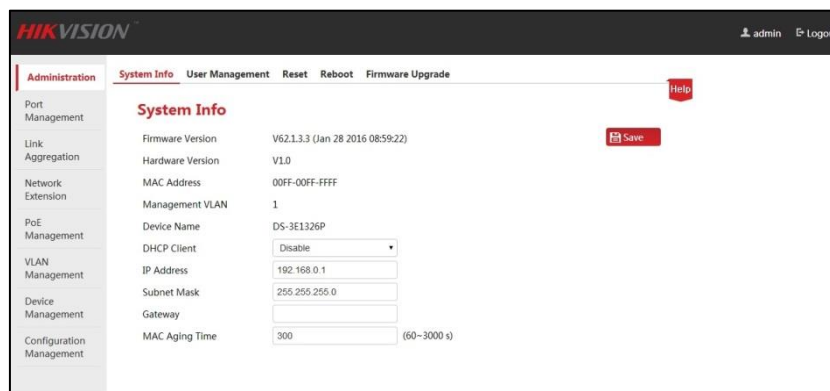

Nota: Per informazioni dettagliate sul funzionamento dello switch di rete, fare riferimento al manuale utente del particolare modello, che può essere scaricato da www.hikvision.com.

SUPPORTO TECNICO

In caso di problemi, contattare immediatamente il servizio di assistenza locale autorizzato da Hikvision.

Deze handleiding is van toepassing op de volgende producten:

Netwerk-switches uit de DS-3EXXXXP-E- en DS-3DXXXP-serie.

Veiligheidsinstructie:

Lees deze handleiding zorgvuldig door voordat u het product installeert en gebruikt, en bewaar deze op een geschikte plaats.



Waarschuwingen:

- De juiste configuratie van alle wachtwoorden en andere beveiligingsinstellingen is de verantwoordelijkheid van de installateur en/of eindgebruiker.
- Houd u bij gebruik van het product aan de nationale en regionale veiligheidsregelgeving voor elektriciteit. Raadpleeg de technische specificaties voor gedetailleerde informatie.
- In navolging van standaard IEC60950-1 moet de ingangsspanning voldoen aan zowel de SELV-standaard (veiligheidsstandaard voor extra lage spanning) als de standaard voor beperkte voedingsbronnen met 100 tot 240 V wisselstroom of 12 V gelijkstroom. Raadpleeg de technische specificaties voor gedetailleerde informatie.
- Sluit niet meerdere apparaten aan op één voedingsadapter. Overbelasting van de adapter kan leiden tot oververhitting en brandgevaar.
- Plaats de stekker stevig in het stopcontact.
- Als het apparaat rook, geur of geluid produceert, moet u het direct uitschakelen en de voedingskabel verwijderen. Neem vervolgens contact op met het servicecentrum.



Let op

- Zorg dat het apparaat in een goed geventileerde en stofvrije omgeving wordt geplaatst.
- Het apparaat is alleen bedoeld voor gebruik binnenshuis.
- Breng het apparaat niet in contact met vloeistoffen.
- Zorg ervoor dat de omgevingsomstandigheden voldoen aan de fabrieksspecificaties.
- Zorg ervoor dat het apparaat stevig is bevestigd in een rek of schap. Als het apparaat harde schokken en stoten ondergaat als gevolg van een val, kan dit leiden tot schade aan de gevoelige elektronica in het apparaat.
- Gebruik het apparaat indien mogelijk in combinatie met een UPS (niet-onderbreekbare voedingsbron).
- Schakel het apparaat uit voordat u accessoires en randapparatuur aansluit of verwijdert.
- Gebruik een door de fabrikant aanbevolen HDD voor dit apparaat.
- Onjuist gebruik en onjuiste vervanging van de batterij kunnen leiden tot explosiegevaar. Vervang de batterij alleen door hetzelfde of een vergelijkbaar type. Gooi gebruikte batterijen weg in overeenstemming met de instructies van de batterijfabrikant.

Kennisgeving met betrekking tot handelsmerken

HIKVISION en andere handelsmerken en logo's van Hikvision zijn het eigendom van Hikvision in verschillende rechtsgebieden. Andere handelsmerken en logo's die hieronder worden vermeld, zijn het eigendom van de respectieve eigenaars.

Wettelijke vrijwaring

VOOR ZOVER WETTELIJK IS TOEGESTAAN DOOR HET TOEPASSELIJK RECHT, WORDT HET BESCHREVEN PRODUCT, INCLUSIEF HARDWARE, SOFTWARE EN FIRMWARE, GELEVERD IN DE HUIDIGE STAAT ('AS IS'), INCLUSIEF GEBREKEN EN FOUTEN. HIKVISION VERLEENT GEEN GARANTIES, HETZIJ EXPLICIET, HETZIJ IMPLICIET, INCLUSIEF MAAR NIET BEPERKT TOT VERKOOPBAARHEID, VOLDOENDE KWALITEIT, GESCHIKTHEID VOOR EEN BEPAALD DOEL EN NIET-INBREUKMAKENDHEID. IN GEEN GEVAL KUNNEN HIKVISION, HAAR DIRECTEURS, BESTUURSLEDEN, WERKNEMERS OF AGENTEN AANSPRAKELIJK WORDEN GESTELD DOOR U VOOR BIJZONDERE SCHADE, GEVOLGSCHADE, SCHADE DOOR ONGEVALLLEN OF INDIRECTE SCHADE, WAARONDER SCHADE DOOR VERLIES VAN BEDRIJFSWINST, BEDRIJFSONDERBREKINGEN EN VERLIES VAN GEGEVENS OF DOCUMENTATIE, DIE HET GEVOLG IS VAN HET GEBRUIK VAN DIT PRODUCT, ZELFS WANNEER HIKVISION OP DE HOOGTE WAS VAN DE MOGELIJKHEID VAN DERGELIJKE SCHADE.

WAT BETREFT HET PRODUCT MET INTERNETTOEGANG, GELDT DAT HET PRODUCT GEHEEL OP EIGEN RISICO WORDT GEBRUIKT. HIKVISION KAN NIET VERANTWOORDELIJK WORDEN GESTELD VOOR INCORRECTE WERKING, PRIVACYLEKKEN OF ANDERE SCHADE DIE HET GEVOLG IS VAN CYBERAANVALLEN, HACKERSAANVALLEN, VIRUSCONTROLES OF ANDERE INTERNETBEVEILIGINGSRISICO'S. HIKVISION ZAL ECHTER TIJDIGE TECHNISCHE ONDERSTEUNING BIEDEN INDIEN DEZE VEREIST IS.

DE SURVEILLANCEWETGEVING VERSCHILT PER RECHTSGEBIED. CONTROLEER ALLE TOEPASSELIJKE WETGEVING IN UW RECHTSGEBIED VOORDAT U DIT PRODUCT GEBRUIKT OM ERVOOR TE ZORGEN DAT UW GEBRUIK CONFORM HET TOEPASSELIJK RECHT IS. HIKVISION KAN NIET VERANTWOORDELIJK WORDEN GESTELD WANNEER HET PRODUCT VOOR ONRECHTMATIGE DOELEINDEN WORDT GEBRUIKT.

IN HET GEVAL VAN CONFLICTEN TUSSEN DEZE HANDLEIDING EN HET TOEPASSELIJK RECHT, HEEFT HET TOEPASSELIJK RECHT VOORRANG.



GEPRODUCEERD DOOR:

Hangzhou Hikvision Digital Technology Co. Ltd.
Qianmo Road 555, Binjiang District, Hangzhou
310052, China
Geproduceerd in China

CONTACTGEGEVENS:

Hangzhou Hikvision Digital Technology Co. Ltd.
Qianmo Road 555, Binjiang District, Hangzhou
310052, China
Tel.: +86-571-8807-5998
Fax: +86-571-8993-5635

In dit document wordt de procedure beschreven voor het gebruik van de netwerk-switch.

Stap 1 Sluit de switch met een Ethernet-kabel via de RJ45-poort aan op externe apparaten.

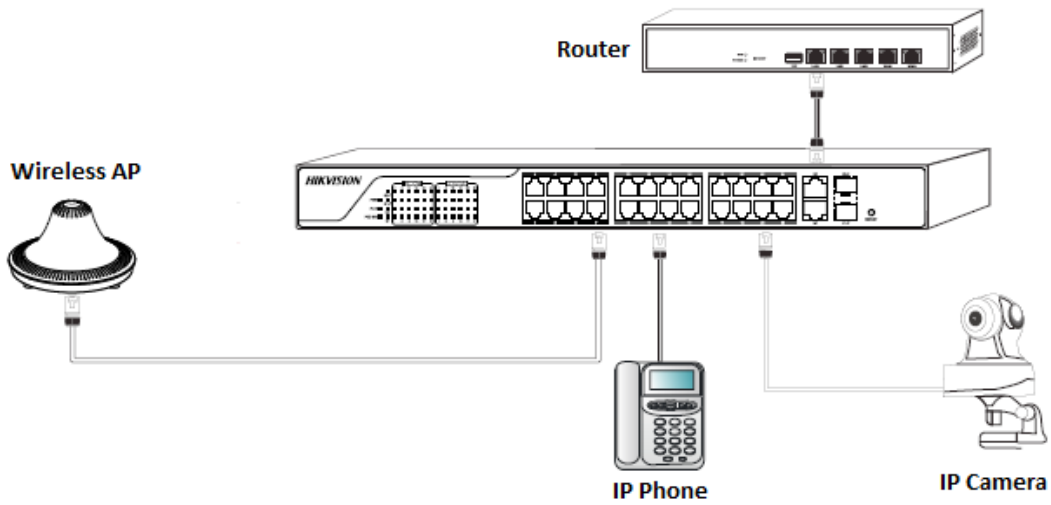

Stap 2 Voor modellen met een SFP-poort sluit u de optische module aan op de SFP-poort.

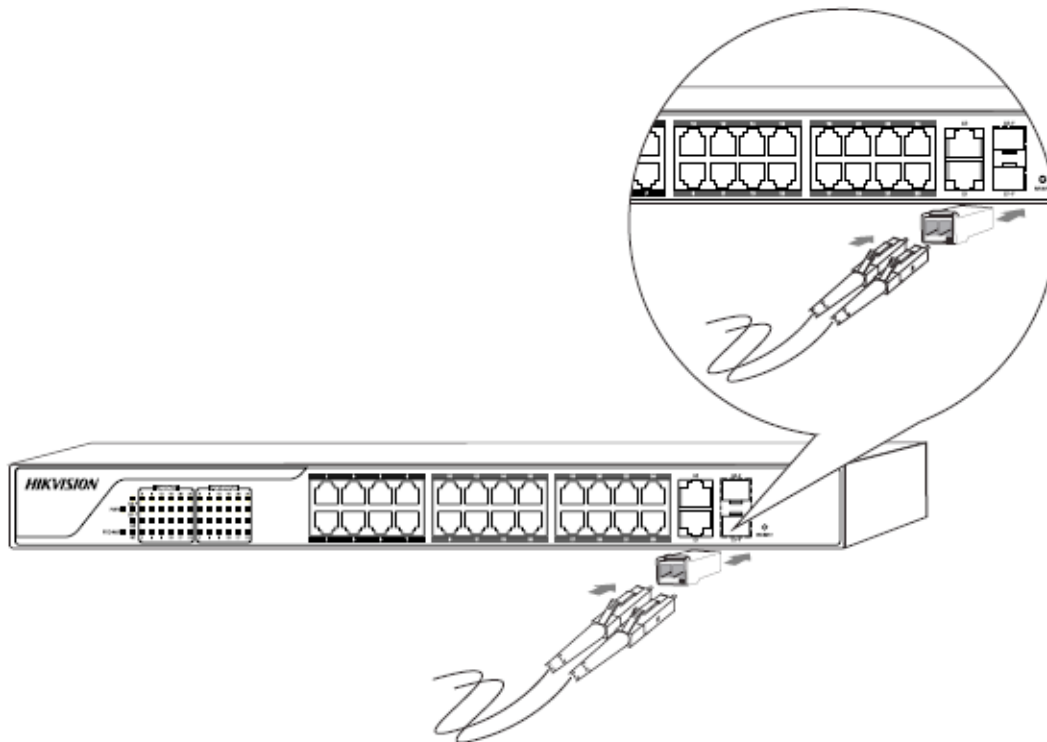

Stap 3 Controleer of de bekabeling van het apparaat als volgt is.

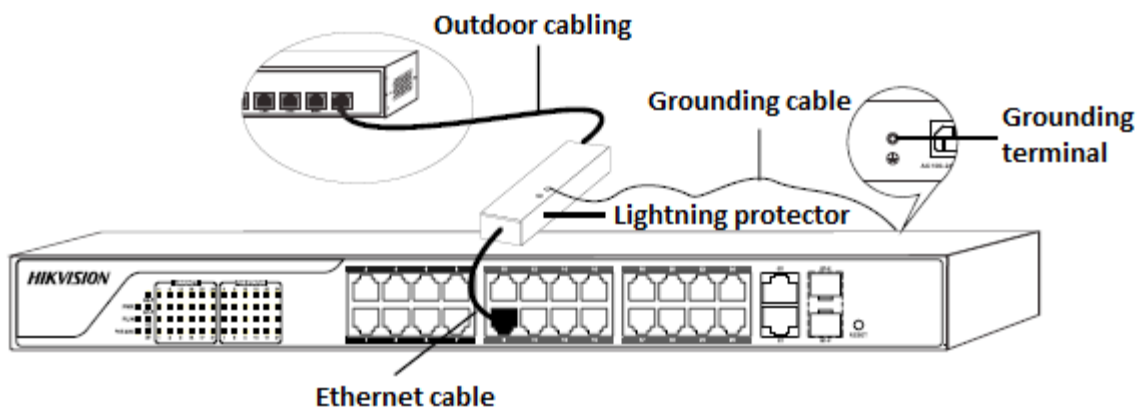

Stap 4 Sluit de switch aan op de voeding.

Stap 5 Sluit een switch met een Ethernet-kabel via de RJ45-poort aan op een pc.

Stap 6 Configureer het IP-adres van de pc als 192.168.0.x ('x' is hierbij een getal in het bereik 2-254) en stel het subnetmasker in op 255.255.255.0.

Stap 7 Meld u aan bij de switch door het standaard-IP-adres in te voeren op de adresbalk en druk op Enter.

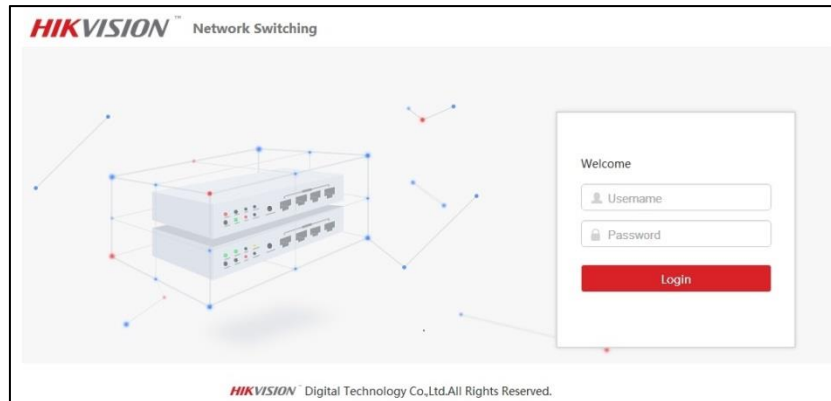

Stap 8 Configureer de switch-parameters naar wens.

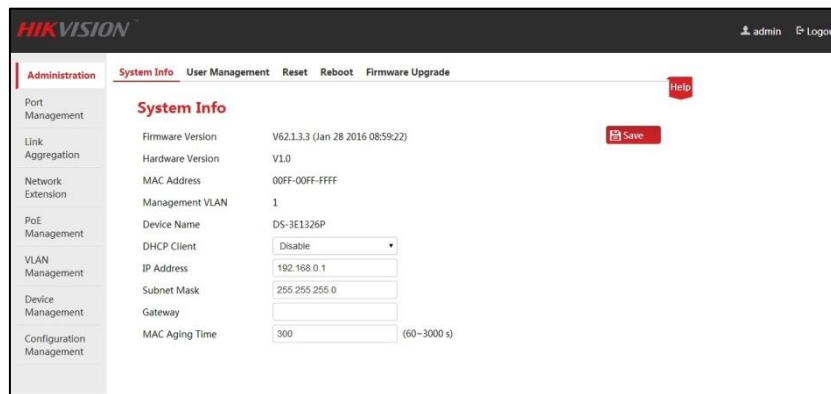

Opmerking: Raadpleeg de gebruikershandleiding voor uw specifieke netwerk-switch-model voor gedetailleerde bedieningsinstructies. U kunt deze downloaden van www.hikvision.com.

TECHNISCHE ONDERSTEUNING

Neem bij problemen onmiddellijk contact op met de lokale aftersale-service die door Hikvision is goedgekeurd.



First Choice for Security Professionals